

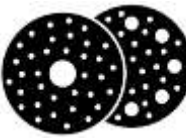

CAPEC
WORK PROJECT

PRODUCTS
CATALOG

LIANTONIO
VERNICI





La nostra rete di distribuzione è in grado di soddisfare
Le esigenze di tutti i rivenditori della Puglia, Basilicata,
Molise, Abruzzo, Marche, Sicilia, Campania, Lazio e Umbria

Siamo rivenditori UFFICIALI
di due aziende che garantiscono qualità e affidabilità.



BORMA WACHS[®]
Wood Professional Cosmetics

Azienda leader nella realizzazione di prodotti per la cura , protezione e restauro del legno e del trattamento delle superfici sintetiche ; si impegna anche alla realizzazione di prodotti per il decoro del legno, come con la pittura Shabby , di tendenza e molto amata dal cliente finale.

Identificare il marchio Borma Wachs in una frase ?

“ IL LEGNO COME MATERIA, LA QUALITA' COME VOCAZIONE”.



I prodotti Decotric sono una garanzia per chi vuole proporre ai propri clienti soluzioni di altissima qualità , indispensabili per un assortimento merceologico completo e ottenere ottimi risultati in ogni intervento di edilizia

Decotric mette a disposizione dell'applicatore una gamma di prodotti completa , mirata a ripristinare , stuccare, rasare, incollare qualsiasi tipo di supporto nel minor tempo possibile e con dei risultati eccellenti di finitura.

Pochi prodotti per molteplici usi , semplificano il lavoro di professionisti , decoratori e cartongessisti.



Liantonio Vernici nasce nel 1989 nella zona di Bari, quando **Nicola Liantonio** acquisisce una fabbrica di idropitture e inizia un percorso di crescita aziendale.

In seguito all'affiliazione con il gruppo **Capec**, amplia notevolmente la sua offerta distributiva.

Nel 2018 prende il testimone il figlio **Michele Liantonio**, che assume il ruolo di guida dell'azienda, preservando e sviluppando ancora di più l'eredità ricevuta.

Oggi Liantonio Vernici dispone di un vastissimo catalogo professionale di prodotti chimici, attrezzature per colorifici, ferramenta e brico. Ha al suo attivo oltre 1000 clienti e un deposito di 2500 mq. che raccoglie oltre 6.000 referenze.

La sede è situata nelle immediate vicinanze e del casello autostradale per Napoli/Pescara che dell'aeroporto di Bari. Una zona strategica, ben collegata, che facilita l'arrivo e la partenza dei prodotti. Così la Liantonio Vernici è in grado di soddisfare le esigenze di tutti i rivenditori della Puglia, Basilicata, Molise, Abruzzo e Marche con un assortimento di prodotti di tutto riguardo.

Ultimamente **Michele Liantonio**, sempre attento ai cambiamenti del mercato, ai nuovi paradigmi tecnologici e organizzativi, alle richieste e aspettative da parte dei clienti e dei collaboratori, ha sentito la necessità di aumentare l'efficienza aziendale, operando scelte coraggiose, ponendo un'attenzione continua all'innovazione e alla sostenibilità delle misure adottate, attivando e rinnovando continuamente un sito web moderno e intuitivo in cui si indicano prezzi e disponibilità dei prodotti presenti in magazzino, consentendo rifornimenti veloci e precisi, ottimizzando la gestione interna dell'azienda e velocizzando l'inserimento e trasmissioni degli ordini. Inoltre è attiva anche la pagina facebook, dove si pubblicano tutte le novità introdotte nel catalogo.

La Liantonio Vernici è quindi, in costante crescita, in ogni momento studia profondamente gli articoli all'avanguardia, altamente professionali, inserendo prodotti nuovi e di alta qualità, con un' ottimo rapporto qualità/prezzo, in modo da soddisfare sempre le esigenze della sua clientela.

categorie

 <p>STUCCATURA MURALE Pagina 1</p>	 <p>STUCCHI PER LEGNO & CARROZZERIA Pagina 11</p>	 <p>INCOLLAGGIO PROFESSIONALE Pagina 17</p>	 <p>LINEA SIGILLANTI Pagina 23</p>
 <p>INCOLLAGGIO FAI DA TE Pagina 27</p>	 <p>NASTRI ADESIVI UNIVERSALI Pagina 33</p>	 <p>MASCHERATURA & PROTEZIONE Pagina 43</p>	 <p>ACCESSORI PER TAPPEZZIERI Pagina 49</p>
 <p>ACCESSORI PER PITTORI & CARTONGESSO Pagina 59</p>	 <p>RULLI – PENNELLI & DECORI Pagina 85</p>	 <p>MODANATURE NMC Pagina 103</p>	 <p>PROFILI DECORATIVI Pagina 115</p>
 <p>ABRASIVI & TAGLIO Pagina 125</p>	 <p>DISPOSITIVI DI PROTEZIONE DPI Pagina 137</p>	 <p>ELETTROUTENSILI Pagina 145</p>	 <p>SCALE & PONTEGGI Pagina 151</p>
 <p>SMALTI E FINITURE Pagina 165</p>	 <p>RISANAMENTO MURALE Pagina 179</p>	 <p>RISANAMENTO TERRAZZE - MURI Pagina 189</p>	 <p>TRATTAMENTO DEL LEGNO Pagina 197</p>
 <p>RESTAURO LEGNO & DORATURA Pagina 205</p>	 <p>DETERGENZA & CHIMICA Pagina 225</p>	 <p>LINEA SPRAY Pagina 237</p>	 <p>ARTICOLI PER LA CASA Pagina 247</p>



A			
		Cartone per protezione pavimento	46
Articoli per la casa	247	Catalizzatore in pasta	15
Accessori per profili cartongesso	78-79-80	Catalizzatore liquido	15
Acciaio liquido pattex	31	Catalizzatori per vernici all'acqua	211
Acetone puro	231	Catramina bituminosa	172
Acido citrico	232	Cemento bianco	9
Acido cloridrico	229	Cemento grigio	9
Acido tamponato	229	Cemento rapido	9
Acqua ragia	230	Cemento refrattario	9
Acrilici pastello ricolora	176	Cera carnauba	213
Adattatore per spatole leviganti	64	Cera d'api naturale	213
Alcool etilico	231	Cera liquida per mobili	215
Altea pittura superlavabile	180	Cera per pavimenti	195-196
Ammoniaca concentrata	219	Cera solida per mobili	214-215
Antialga algen & shimmel	185	Cera solida per stucchi	214
Antimuffa concentrato	185	Cesoia	77
Antimuffa shimmel	185	Chiodini in acciaio	55
Antirombo bituminoso	172	Colla cianoacrilata	31
Antisalnitro	191	Colla di coniglio	213
Antitarlo	218	Colla di montaggio	29
Articoli per la casa	247	Colla in perle	213
Asta telescopica per spatole	64	Colla intonaco per cornici	20
Astuccini per ritocchi	96-97	Colla neopremica	32
B		Colla per carta da parati in pasta	18
Battiscopa in duropolimero	111	Colla per carta da parati in polvere	21-22
Battiscopa in pvc	121	Colla per fibra di vetro	18
Biadesivo per telai cartongesso	81	Colla per fibra di vetro in polvere	21
Bidoni aspira polveri	147	Colla per pavimenti in pasta	19
Botola d'ispezione per cartongesso	80	Colla per piastrelle	8
Briza traspirante	181	Colla per polistirolo	20
C		Colla per sughero	20
Carta abrasiva	127-128	Colla poliuretanic	31
Carta asciugatutto in rotolo	234	Colla termofusibile	30
Carta igienica maxi roll	236	Colla universale in pasta	19
Carta per mascheratura	44	Colla vinilica	28-30
Carta per ristrutturazione	6	Coloranti concentrati per legno	208
Carteggiatrici 220v	146	Coloranti concentrati universali	187-188

Coltello a caldo per polistirolo	149	Film pellicola estensibile	47
Coltello per lana di roccia	76	Filtri per maschere filtranti	139
Coltello universale	77	Finitura per metalli	172
Consolidante per legno	210	Finitura/vernice effetto metallo	220-221
Convertitore di ruggine	229	Finiture a cera per legno	201
Coprispigolo assorbi urto	116	Fissativo termico	184
Coprispigolo in pvc	117	Flatting marino acqua/solvente	202
Cornici a parete in duropolimero	110	Flessometro	75
Cornici in polistirolo	da 104 a 108	Foglia oro/argento imitazione	224
Cornici in polistirolo porta LED	109	Fondo all'acqua river	178
Crema lavamani	233	Fondo ancorante	171
Creme lucidanti	226	Fondo antiruggine all'acqua	175
Creolina	229	Fondo antiruggine sintetico	168
Cuffia per lucidatura	136	Fondo antitannino per legno	211
Cutter da taglio	56-57	Fondo cementite all'acqua	175
D		Fondo cementite sintetico	168
Detergente per vetri	228	Fondo turapori per legno	210
Detergenti per legno	203	Forbici in titanio	55
Detergenti per mobili/infissi in legno	216	Fratteggio per panni abrasivi	73
Detergenti per plastica	228	Fratteggio in acciaio	65
Deumidificatori	236	Fratteggio in gomma/spugna	72
Diluenti nitro	230	Fratteggio in PVC	65
Diluenti sintetici	230	Fratteggio per colle	70
Diluenti universali	230	Frattegni per decori	99
Dima per cornici	51	Fruste per colle	63
Dischi abrasivi	135-136	Fruste per vernici	63
Dischi abrasivi in tungsteno	131	G	
Dischi da taglio	133-134	Gesso alabastrino	8
Dischi lamellari	127	Gesso bologna	213
Disgorgante liquido/granulare	232	Gesso rapido	8
Disossidante per metalli	229	Glitter decorativi	223
Dispencer per carta mascheratura	44	Gommalacca in scaglie	212
Dopo posa concentrato	229	Gommalacca liquida	212
Doppimetro	75	Grassi lubrificanti in pasta	234
Dust kit antipolvere	50	Guaina liquida	190
E		Guanti da lavoro	142
Essenza di trementina	230	Guanti da lavoro monouso	141
F		Guanto per decori	98
Feltro assorbente	46		
Film bolle aria pluriboll	47		

I		Nastro per imballo adesivo	37
Idrorepellente siliconico	190-191	Nastro segnaletico	143
Impregnanti per legno a solvente	199-200	Nastro teflonato	42
Impregnanti per legno all'acqua	198-200	Nastro telato	41
Impregnanti per marmo	191-192	Nastro trasparente adesivo	37
Impugnature per rulli	90	O	
Intonaco pronto	9	Occhiali di protezione	140
Iris plus pittura antimuffa	181	Olea pittura lavabile	180
Isolante fissativo	183	Oli per legno esterno/interno	203-204
Isolante fissativo antimuffa	183	Oli per saune	204
Isolante neutralizzante	184	Oli per taglieri in legno	204
L		Olio di lino	231
Lame per cutter da taglio	58	Olio restauro per mobili	216-217
Lame per raschietti	58	Ossidi coloranti	188
Lame ricambio per coltello a caldo	150	P	
Lana acciaio mobiliari	209	Pannelli decorativi in polistirolo	113
Lana di vetro	15	Pannelli fonoassorbenti	114
Laurus pittura supertraspirante	181	Pannelli in polistirolo	114
Livella in alluminio	74	Pannelli isolanti pufatherm	6
M		Panni abrasivi	129
Manico telescopico	62	Paparella incartatrice	44
Martelli	74	Paraffina solida	213
Maschere filtranti	139	Patina anticante	223
Mascherina facciali monouso	138-139	Patina per doratori	224
Matita da carpentiere	82	Pellicola isolante in alluminio	184
Mescolatori - apribarattolo	63	Pennarelli marker	83-84
Mini rulli per vernici	91-92	Pennellesse	94-95
Miscelatore 220v	149	Pennelli per belle arti	96
Muffa stop	185	Pertiche telescopiche	62
N		Petrolio lampante	231
Nastri adesivi antisdrucchiolo	143	Pialla per cartongesso	77
Nastri asegnalatici adesivi	144	Pinza	76
Nastri carta adesivi	34-35-36	Pistola a spruzzo 220v	149
Nastro alluminio adesivo	40	Pistola estrusore per silicone	71
Nastro autofondente	40	Pistola nastratrice	37
Nastro biadesivo spessorato	38-39	Pistola per colla termofusibile	30
Nastro biadesivo telato	40	Pittura al quarzo kalika	182
Nastro carta per giunti cartongesso	81	Pittura al quarzo kalos	182
Nastro isolante elettrico	42	Pittura isolante	186

Pittura termoisolante thermo	182	Sapone lavamani	233
Plafoncino	93	Sbiancante per legno	210
Plafoniera antigoccia	93	Scagliola alabastrino	8
Polietilene per mascheratura	44	Scale domestiche	156-157
Polvere per tracciatore a piombo	82	Scale doppie	152
Profili in alluminio argento lucido	124	Scale telescopiche	153
Profili in alluminio per pavimento	118-119	Scatola in cartone per spedizione	47
Profili in alluminio satinato	122-123	Schiuma poliuretana	24
Pulitore per schiuma poliuretana	24	Scrostatore ad aghi	132
R		Sealstick sigillante lavelli	26
Raschietti multiuso	52	Secchi in plastica	60
Resina epossidica	223	Sgabelli uso domestico	158-159
Resina poliestere	15	Sgrassatori	227
Rete porta intonaco	7	Sgusce igieniche in pvc	120
Rete scolarullo	61	Shabby provenzale	222
Ricambi per aspira polveri	150	Sigillante acrilico	25
Ricambi per carteggiatrice	150	Sigillante adesivo	25
Ricambi per taglierina polistirolo	148	Sigillante per parquet	13
Rimuovi adesivi	227	Silicone antimuffa	25
Rimuovi graffiti	227	Silicone neutro	26
Rimuovi ruggine	227	Smalti sintetici uretanici	166-167
Rimuovi silicone	227	Smalto a rapida essiccazione	169
Rinnovatore per legno	203	Smalto all'acqua alta copertura	174-175
Ritocchi per legno	206-207	Smalto all'acqua river	178
Rosoni in polistirolo	112	Smalto antiruggine 3in1	170
Rotella metriche	75	Smalto micaceo	169
Rulli per idropitture	86-87-88-89	Smalto multisuperficieall'acqua	173
Rullini premigiunto per parati	54	Smalto murale antigraffio	178
Rullo con serbatoio	90	Smalto murale zahir	180
Rullo in pelle per decori	99	Smalto per alte temperature	169
Rullo in spugna	97	Smalto per sanitari	171
Rullo per angoli	91	Smalto per termosifoni	175
Rullo per stucchi	89	Smerigliatrice manuale	126
S		Soda/sodina	232
Sacchi per pattumiera	235	Sodio carbonato	232
Saldatutto pattex	31	Spalter	97
Sali per deumidificatori	236	Spatole in acciaio	69
Salvaparete in pvc	116	Spatole in acciaio con manico	66-67-70
Salviette lavamani	233	Spatole in plastica	69

Spatole leviganti	64	Stucco per fughe	8
Spatole per colle	68	Stucco per legno	12-14
Spatole/spazzole per parati	53-54	Stucco per marmo	16
Spazzole in acciaio manuali	131	Stucco per metallo	16
Spazzole in acciaio per smerigliatrice	130	Stucco per vetri	13
Spazzole in acciaio per trapano	130	Stucco per vetroresina	16
Spingi acqua	73	Stucco sintetico	13
Spray acrilici tinte ral	238-239	Sughero in rotolo	114
Spray colle removibili/permanenti	246	Supporti porta pennelli	61
Spray coprimacchie	246	Sverniciatori	219
Spray fondi/ancoranti	245	T	
Spray lubrificanti	240-241	Taglierina per polistirolo	148
Spray protettivi	242-243	Tamponi in pelle per decori	99
Spray pulitori	244	Tamponi per decori	98
Spray traccianti/marker	246	Tassello chimico	24
Spugne per decori	98	Tavoli per tappezziere	50
Spugne sintetiche	73	Tazza filtrante	82
Spugnette abrasive	128	Tazza in gomma	61
Staccaparati	20	Teli copritutto	45-48
Stencil per decori	100-101-102	Teli occhiellati	48
Stucco alleggerito	10	Tenaglia	76
Stucco in pasta	10	Terre coloranti	188
Stucco in pasta decofill facade & feuchtraum	4	Tnt fibra di vetro	6
Stucco in pasta decofill instantspachtel	4	Trabattelli	154-155-163-164
Stucco in pasta decomur fill+finish spachtel	4	Trabattelli/ponteggi	160-161-162
Stucco in pasta decomur leicht fuller L10	4	Tracciatore a piombo	82
Stucco in pasta decomur tiefenfuller	4	Travi rustiche finto legno	113
Stucco in polvere	8	Trielina	231
Stucco in polvere decofill auben spachtel	1	V	
Stucco in polvere decofill fullspachtel innen	2	Vassoio in plastica	60
Stucco in polvere decoplast V30 - ultra	1	Velcro adesivo ricambio per platorelli	126
Stucco in polvere glatt und fullspachtel	3	Vernice ignifuga	202
Stucco in polvere glatt und fullspachtel 860	3	Vernice per doratori	224
Stucco in polvere k2	7	Vernice per mobili all'acqua	211
Stucco in polvere l'anticondensa	7	Vernice per parquet/laminati	193-194-195
Stucco in polvere new stucco restauro	7	Vernice per pietra	195
Stucco in polvere power painter's + dry MT75	2	Vernice plastificante	172
Stucco nautico	16	Vernice spartitraffico	168
Stucco per cartongesso	8	Zincante a freddo	171

Settori consultabili su Web – E-commerce – Rete vendita



Pavimento/pellicola adesiva



STUCCATURA MURALE & armatura professionale

- Stucchi in polvere base gesso
- Stucchi in polvere base cemento
- Stucchi in pasta per interno
- Stucchi in pasta per esterno
- Linea Briko
- Pannelli in polistirolo termoisolanti per cappotto
- TNT legante
- Rete sotto intonaco in fibra

ORIGINAL
decotric

CAPEC
WORK PROJECT



BORMA WACHS
Wood Professional Cosmetics

K2 | **PRIMA**



DECOPLAST V30 - ULTRA

STUCCO IN POLVERE PER SUPERFICI E PIASTRELLE

E' il prodotto ideale per ritoccare, levigare, livellare e rivestire tutti i sottofondi minerali come intonaco di calce, cemento e gesso, calcestruzzo, calcestruzzo poroso, mattoni e fondi a dispersione aderenti come intonaci di resina sintetica e vecchi strati di idropittura.

Non adatto per il livellamento di pavimenti e per le stuccature su legno, metallo, plastica.

Campi d'applicazione:

- Piastrelle smaltate
- Vetro cemento
- Fibra di vetro
- Vecchie pitture
- Plastici a base di calce
- Sottofondi minerali
- Intonaci
- Facciate
- Spessore max da 0/10 cm



Spessore
0/10 cm



CODICE	CONFEZIONE
06031	Gr. 750
06032	Kg. 5
06033	Kg. 15



DECOFILL Außen spachtel

STUCCO IN POLVERE PER ESTERNO

Stucco a base di cemento rinforzato con resina sintetica, per interni ed esterni.

E' adatto per ritoccare, levigare e rivestire i sottofondi minerali come intonaco di calce, cemento e gesso, calcestruzzo, calcestruzzo poroso, mattoni ecc., come pure per l'incollaggio di piastrelle di ceramica.

Le superfici intonacate sono facilmente levigabili e frattazzabili.

Non adatto per le stuccature su legno, metallo, plastica, vetro e idropitture.

Campi d'applicazione:

- Intonaco di calce
- Cemento e gesso
- Calcestruzzo
- Mattoni
- Incollaggio di piastrelle



Spessore
0/10 cm



CODICE	CONFEZIONE
06020	Kg. 1
06021	Kg. 5



POWER PAINTER'S + DRY CONSTRUCTION FILLER MT75

STUCCO IN POLVERE PER INTERNO

Stucco a base di gesso rinforzato con resine sintetiche per interni. Consente di ottenere supporti lisci e privi di tensioni superficiali per i successivi rivestimenti con carta da parati o lavori di imbiancatura.

Stucco MT 75 è indicato per il riempimento di crepe e fori, la rasatura a piena superficie, la sigillatura delle giunzioni tra i pannelli in cartongesso, fibra di gesso e fibrocemento, coperture in calcestruzzo nonché per strutturare e modellare.

Campi d'applicazione:

- Sottofondi minerali
- Intonaco
- Pietra
- Calcestruzzo
- Gasbeton
- muratura



Spessore
0/15 cm



POWER PAINTERS MT75

CODICE	CONFEZIONE
06012	Kg.10
06013	Kg. 20

DECOFILL FULLSPACHTEL Innen

STUCCO IN POLVERE PER INTERNO

È uno stucco bianco a base di gesso, particolarmente indicato per la rasatura a piena superficie di pareti e soffitti, la sigillatura delle fughe nei prefabbricati in calcestruzzo e per il riempimento di crepe e fori. Ideale anche per la sigillatura delle giunzioni e la stuccatura di pannelli in cartongesso di qualità da Q1 a Q4 montati senza tensione. Il prodotto è indicato per i fondi minerali (come ad es. intonaco di cemento e gesso, calcestruzzo, gasbeton e muratura).

Campi d'applicazione:

- Intonaco di calce
- Cemento e gesso
- Calcestruzzo
- Mattoni
- Incollaggio di piastrelle



Spessore
0/10 cm



DECOFILL FULLSPACHTEL INNEN

CODICE	CONFEZIONE
06034	Kg. 1
06035	Kg. 5
060351	Kg. 10
06036	Kg. 25

GLÄTT UND FULLSPACHTEL Innen

STUCCO IN POLVERE PER INTERNO

Particolarmente indicato per lisciare superfici di grandi dimensioni e per la sigillatura delle giunzioni tra i pannelli in cartongesso e altri pannelli prefabbricati mediante nastro d'armatura. Lo Stucco per lisciare e riempire decotric è indicato per tutti i supporti minerali (p.es., intonaco a base di gesso, calce e cemento, calcestruzzo, mattoni, ecc.) come pure per i pannelli in cartongesso, fibra di gesso e altri pannelli prefabbricati. Non è indicato per stuccature su legno, vetro, materie plastiche e metallo.

Campi d'applicazione:

- Cartongesso
- Intonaco a base gesso
- Calce e cemento
- Calcestruzzo
- Mattoni



Spessore
0/10 cm



CODICE

CONFEZIONE

06037

Kg. 5

06038

Kg. 10

06039

Kg. 25



GLÄTT & FULLSPACHTEL 860

STUCCO IN POLVERE PER INTERNO

Particolarmente indicato per lisciare superfici di grandi dimensioni e per la sigillatura delle giunzioni tra i pannelli in cartongesso e altri pannelli prefabbricati mediante nastro d'armatura. Lo Stucco per lisciare e riempire è indicato per tutti i supporti minerali (p.es., intonaco a base di gesso, calce e cemento, calcestruzzo, mattoni, ecc.) come pure per i pannelli in cartongesso, fibra di gesso e altri pannelli prefabbricati.

Campi d'applicazione:

- Cartongesso
- Intonaco a base gesso
- Calce e cemento
- Calcestruzzo
- Mattoni
- Pannelli prefabbricati



Spessore
0/10 cm



CODICE

CONFEZIONE

06043

Kg. 10



DECOFILL Instantspachtel

Stucco universale a base di calce, cemento e gesso.
Per usi interno/esterno

Spessore
0/5 mm



DECOFILL INSTANTSPACHTEL

Cod. art. 06058 06059

Formato Kg.1 Kg.4

DECOMUR Tiefenfuller

È uno stucco extra bianco ultraleggero.

Spessore
0/4 cm



DECOMUR TIEFENFULLER

Cod. art. 06826

Formato ml.750

DECOMUR Leicht Fulller L10

Stucco ultraleggero per riempire e stuccare elementi decorativi. Dopo l'essiccazione rimane elastico e carteggiabile.

Spessore
0/15 mm



DECOMUR LEICHT FULLER L10

Cod. art. 06045

Formato ml.310

DECOFILL Fassade & Feuchtraum

Stucco in pasta bianco pronto all'uso per tutte le pareti e i soffitti in interni ed esterni.

Spessore
0/5 mm



DECOFILL FASSADE & FEUCHTRAUM

Cod. art. 06041

Formato Gr.400

DECOMUR FILL+FINISH SPACHTEL READY

STUCCO IN PASTA PER INTERNO

Stucco leggero a base di resina sintetica, pronto all'uso, privo di solventi e plasticizzanti, indicato per riparare, lisciare e uniformare pareti e soffitti in ambienti interni.

Campi d'applicazione:

- Fibra di vetro
- Polistirolo
- Supporti minerali
- Cartongesso



Spessore
0/3 mm



DECOMUR FILL+FINISH SPACHTEL READY

CODICE CONFEZIONE

06056 Kg. 20

CAPPOTTO INTERNO a basso spessore

Sono pannelli termoisolanti per uso interno. Grazie allo speciale rivestimento di incollaggio bianco, le tavole possono essere immediatamente tappezzate e dipinte. Riduce la permeabilità al vapore acqueo. Previene la formazione di muffe grazie all'effetto di protezione dall'umidità di pareti e soffitti e quindi migliora il clima interno. Uniforma lievi irregolarità della superficie. Riduce i ponti termici e i ponti termici freddi.
* Fino al 30% in meno di perdita di calore rispetto alla muratura in mattoni che non è stata isolata.

pufatherm®

Campi d'applicazione:

1. Su pareti esterne fredde
2. Su pareti esterne umide
3. Su pareti divisorie fredde
4. Sulle pareti fredde della cantina
5. A ponti di calore, crepe di intonaco
6. Negli angoli
7. A perdita di calore nelle nicchie del radiatore
8. Su finestre a porte rivela
9. Sopra e dentro i cassonetti dell'otturatore
10. Sui muri, dietro i mobili
11. Sui soffitti
12. Sulle pendenze del tetto

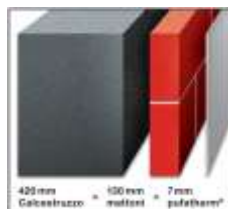

Stuccatura Murale & Armatura professionale



Cod. art.	pannelli	misura
58648	pz. 8	cm 100 x 50

TNT – FIBRA DI VETRO

- ✓ Indicato per essere annegato nelle pitture nei cicli di applicazione di cappotti interni, inserito tra due mani di stucco in pasta. Peso specifico 45g/m² ca



Cod. art.	64698	64699
Misura	H cm100x25 mt	H cm10x10 mt



CARTA PER RISTRUTTURAZIONE

- ✓ Perfetto per i pannelli Pufatherm per colmare grandi crepe superficiali, sopra verniciabile.
- ✓ Ideale per i successivi lavori di tappezzeria
- ✓ Alta qualità grazie all'elevata densità: ca.130 g/m²



Cod. art.	64697
Misura	H cm100x25 mt



RETE PORTA INTONACO IN FIBRA

- ✓ Per intonaci interni/esterni
- ✓ Luce maglia 5 x 5 mm - Grammi x m² 75



Cod. art.	6469.4
misura	H.100 x 50 metri

K2 – STUCCO IN POLVERE

- ✓ Extra fine, ideale per rasatura e finitura delle pareti interne. Facilmente carteggiabile



Cod. art.	0290	0291	0292
Formato	Kg.1	Kg.5	Kg.20



NEW STUK RESTAURO

- ✓ Rasante fine per finiture esterne su calcestruzzo
- ✓ Intonaco e mattoni



Cod. art.	0293	0294
Formato	Kg.1	Kg.5



L'ANTICONDENZA

- ✓ Stucco in polvere traspirante
- ✓ Per ambienti con scarsa ventilazione



Cod. art.	0298
Formato	Kg.4



GESO ALABASTRINO



Cod. art.

0669 0669.5

Kg. 1,5 Kg. 5



GESO ALABASTRINO

GESO NORMALE RAPIDO



Cod. art.

0673 0673.5

Kg. 1 Kg. 5



GESO NORMALE RAPIDO

SCAGLIOLA ALABASTRINO



Cod. art.

0672 0672.5

Kg. 1 Kg. 5



SCAGLIOLA ALABASTRINO

COLLA PER PIASTRELLE



Cod. art.

0676 0676.5

Kg. 1 Kg. 5



COLLA PER PIASTRELLE

STUCCO IN POLVERE INTERNO



Cod. art.

0610 0611

Kg. 1 Kg. 5



STUCCO IN POLVERE INTERNO

STUCCO IN POLVERE ESTERNO



Cod. art.

0608 0609

Kg. 1 Kg. 5



STUCCO IN POLVERE ESTERNO

STUCCO PER FUGHE



Cod. art.

0679

Kg. 1



STUCCO PER FUGHE

STUCCO PER CARTONGESSO



Cod. art.

0612 0613

Kg. 1 Kg. 5



STUCCO PER CARTONGESSO

INTONACO PRONTO



Cod. art.

0677

Kg. 1



CEMENTO BIANCO



Cod. art.

0670

0670.5

Kg. 1

Kg. 5



CEMENTO GRIGIO



Cod. art.

0674

0674.5

Kg. 1

Kg. 5



CEMENTO RAPIDO

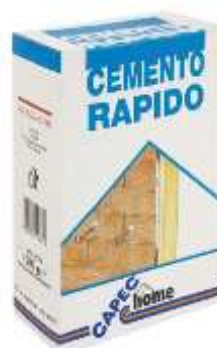

Cod. art.

0671

0671.5

Kg. 1

Kg. 5



CEMENTO REFRATTARIO



Cod. art.

0678

Kg. 1



STUCCO IN PASTA STAR

- ✓ Stucco in pasta pronto all'uso per uso interno.
- ✓ Ottimo potere riempitivo ed ottima resa.
- ✓ Non ingiallisce e imputrisce.
- ✓ Privo di sostanze a solvente.
- ✓ Ottima aderenza su muro o legno.



Cod. art.	0620	0621	0622	0623
Formato	Gr.250	Gr.500	Kg.1	Kg.5



STUCCO STAR LIGHT

- ✓ Stucco ultraleggero in pasta pronto all'uso. per muro e legno, applicabile in interno ed esterno, esente da ritiro.



STUCCO STAR LIGHT



Cod. art.	0627	0628	0629
Formato	ml.250	ml.500	Lt.2,5



ECOSTUCCO ONE GO

- ✓ One Go è uno stucco all'acqua inodore a ridotto peso specifico ed elevato ancoraggio e riempimento.
- ✓ Non cala nemmeno se usato in elevati spessori (10mm).
Colore Bianco



ECOSTUCCO ONE GO



Cod. art.	06150	06151
Formato	ml.300	ml.600



STUCCO A RASARE PRESTO

- ✓ Stucco in pasta pronto all'uso
- ✓ Per muri e soffitti
- ✓ Su grandi superfici



STUCCO A RASARE PRESTO



Cod. art.	0624
Formato	Kg.20



GIESSE STUCCO IN PASTA

- ✓ Stucco in pasta pronto all'uso
- ✓ Ottimo su cartongesso



GIESSE STUCCO IN PASTA



Cod. art.	0297	0296
Formato	Kg. 5	Kg. 20





Stucchi per legno & Carrozzeria

- Stucchi ad acqua
- Stucchi bicomponenti
- Stucchi fibrati
- Stucchi per vetro
- Stucchi nitro
- Sigillanti per parquet
- Resine poliesteri

CAPEC
WORK PROJECT



BORMA WACHS[®]
Wood Professional Cosmetics

ORIGINAL
decotric[®]

ECOSTUCCO IN TUBETTO

Stucco in pasta all'acqua inodore per legno. Bianco indicato anche per rasare muro e legno. Calo limitato. I colori sono stabili alla luce e fra loro miscelabili.

Per uso interno.

TUBETTO da gr.200



Espositore
Pz.36
06650



Bianco
06651

Abete
06652

Ciliegio
06653

Mogano
06654

Rovere
06655

Noce
Chiaro
06656

Noce
Scuro
06657



ECOSTUCCO IN TUBETTO



Kg.1

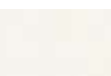

Bianco
15460



Gr.500



Bianco
15450

Noce
Chiaro
15451

Noce
Scuro
15452

Mogano
15453

Rovere
15454

Ciliegio
15455

Abete
15456

Wengè
15457



ECOSTUCCO IN BARATTOLO



ECOSTUCCO STRONG

Fibrostucco all'acqua, formulato con fibre strutturali di notevole elasticità. Di calo pressoché nullo, è particolarmente indicato per la stuccatura e la rasatura del legno.

Per uso interno.

TUBETTO da gr.200



Espositore
06670



Bianco
06671

Pino
06673

Noce Ch.
06674

Noce S.
06676

Rovere
06672

Mogano
06675



ECOSTUCCO STRONG TUBETTO



Kg.1

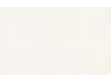

Bianco
06659



Gr.500



Bianco
06660

Ciliegio
06661

Noce Ch.
06662

Noce S.
06663

Mogano
06664

Rovere
06666

Pino
06667



ECOSTUCCO STRONG IN BARATTOLO



STUCCO PER LEGNO STAR

Stucco tipo "francese" in pasta per legno.
Di notevole potere riempitivo, forza adesiva e buona lavorabilità anche con carteggiatura a secco.

[BARATTOLO da gr.500](#)



STUCCO PER LEGNO STAR

Colori



Cod. art.

Douglas
0651

Pino
0662

Noce Ch.
0631

Noce S.
0632

Rovere
0661

Mogano
0641

Ciliegio
0630

PROFI GLASERKITT

STUCCO MASTICE PER VETRI

È un impasto di olio di lino e creta usato dai vetrai per fissare le lastre di vetro ai telai delle porte e delle finestre di legno e metallo.



PROFI GLASERKITT

Cod. art.

0601

Formato

ml.750



ECOSEAL 300KX SIGILLANTE

Sigillante elastico per parquet. Privo di solventi, sovra verniciabile. Adatto per laminato, parquet, multistrato, battiscopa, scale in legno.

[CARTUCCIA da ml.310](#)



ECOSEAL 300KX SIGILLANTE



0492

Rovere
chiaro
51

0493

Rovere
naturale
02



0494

Rovere
Scuro 52

0491

Douglas
54



0490

Noce scuro
63

0495

Iroko
12056



0496

Nero
60

0497

Mogano
62



ELIOMASTIK

STUCCO IN SINTETICO

in pasta per cemento, metallo e legno.
Per uso interno/esterno



ELIOMASTIK

Cod. art.

0625

Formato

ml.500



TOP HOLZ STUCCO PER LEGNO

Stucco in pasta bicomponente, a base di resina poliesteri, per ricostruzioni su legno

Ad uso interno/esterno



TOP HOLZ STUCCO PER LEGNO



Cod. art.	0575	0577	0579	0583
-----------	------	------	------	------

ml.375 Bianco Scuro Chiaro medio

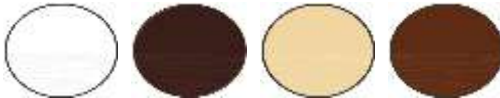

Cod. art.	0574	0576	0578	0584
-----------	------	------	------	------

ml.750 Bianco Scuro Chiaro medio



HOLZMASSE K2 STUCCO PER LEGNO

E' un prodotto a base di resine poliesteri.
Particolarmente consigliato per restauri su legno.



HOLZMASSE K2 STUCCO PER LEGNO



Cod. art.	15430	15431	15432	15433
-----------	-------	-------	-------	-------

ml.125 Bianco Legno chiaro Legno scuro trasparente



ACTIV STUCCO RICOSTRUTTORE

E' un prodotto di rapida essiccazione a base di farina di legno.
Ideale per la ristrutturazione di legni difettati e danneggiati.

Cod. art.
0842
ml.750



NC Noce
chiaro NS Noce
scuro

Cod. art.
0841
ml.250



ACTIV STUCCO RICOSTRUTTORE



NC Noce
chiaro NS Noce
scuro M Mogano R Rovere C Ciliegio D Douglas P Pino T Teak PIO Pioppo F Frassino L Larice



RESINA POLIESTERE SK200

Resina poliesteri. Per riparazioni su plastica
Completo di catalizzatore, Fibra di vetro, Bicchieri



Cod. art. 0544

Formato Gr.200



RESINA POLIESTERE KIT

Resina poliesteri
Per riparazioni su plastica
Completo di catalizzatore
Fibra di vetro da 0,5 mq
Bicchieri e pennello



Cod. art. 0545 0546

Formato ml.375 ml.750



RESINA POLIESTERE LIQUIDA

Per riparazioni di imbarcazioni, carrozzerie, serbatoi
Aderisce su: metallo, vetroresina, plastica, legno,
pietra, cemento, porcellana.
Completo di catalizzatore



Cod. art. 0550 0551 0552

Formato ml.375 ml.750 Litri 4



CATALIZZATORI IN PASTA

Universale bianco



Cod. art. 0536 0537

Formato ml.10 ml.30

LANA DI VETRO



0561

Cod. art. 0561

Formato 1 m²

CATALIZZATORE LIQUIDO



0538

Cod. art. 0538

Formato ml.30

STUCCO GEL COAT LEVANTE

Gel Coat stucco bicomponente
Ideale su strati di vetroresina
Completo di catalizzatore



STUCCO GEL COAT LEVANTE

Cod. art. 0520 0521

Formato Gr.200 Gr.500



TOP GLASS VETRORESINA

STUCCO PER VETRORESINA IN PASTA

Ottime proprietà riempitive. Ottima resistenza meccanica.
Su supporti in alluminio, ottone, zinco vanno preventivamente isolati
con un primer. Completo di catalizzatore



TOP GLAS VETRORESINA

Cod. art. 0540 0541 0542

Formato ml.125 ml.500 ml.750



TOP METAL

STUCCO PER FERRO IN PASTA

Ideale per il settore nautico e industriale
Colore grigio
Completo di catalizzatore



TOP METAL STUCCO METALLO

Cod. art. 0500 0501 0502

Formato ml.125 ml.500 ml.750



TOP STONE

STUCCO PER MARMO IN PASTA

Ideale su pietre, marmo, granito, ceramica e onice.
Completo di catalizzatore



TOP STONE STUCCO MARMO

Cod. art. 0530 0531 0532

Formato ml.125 ml.500 ml.750



Incollaggio professionale

- Pavimenti
- Parati
- cornici

Henkel



WANDBELAGSKLEBER

COLLA PER RIVESTIMENTI DI CARTA DA PARATI E BORDI

Per incollare professionalmente rivestimenti murali pesanti carte da parati goffrate e viniliche, carte da parati scollabili, tessuti di ristrutturazione e rinforzo, nonché tutti i bordi commerciali in carta, vinile o tessuto non tessuto.



WANDBELAGSKLEBER



Cod. art.	1194	1196
formato	Gr.750	Kg.5



NAHT KLEBER

COLLA PER RITOCOCCO DI CARTA DA PARATI E BORDI

Adesivo in emulsione pronto all'uso con elevato potere di adesione. Perfettamente adatto per riparare le cuciture allentate della carta da parati.



NAHT KLEBER



Cod. art.	1193
formato	Gr.60



METYLAN OVALIT

COLLA IN PASTA PER TESSUTI MURALI

ideale per l'applicazione di tessuti murali, parati tessili, juta o fibra di vetro non accoppiati e per l'incollaggio di fogli di plastica metallizzati accoppiati.



METYLAN OVALIT



Cod. art.	1041	1042
Formato	Gr.750	Kg.5



GLASGEWEBE KLEBER GF

COLLA PER FIBRA DI VETRO

Per tessuti in fibra di vetro, carte da parati tessili e rivestimenti murali pesanti. Incollaggio sicuro e duraturo.



GLASGEWEBE KLEBER GF



Cod. art.	1198
formato	Kg.10



BODENKLEBER CLASSIC

COLLA UNIVERSALE PER PAVIMENTI

L'Adesivo classico universale per pavimenti decotric è indicato per incollare rivestimenti tessili per pavimenti, pannelli in espanso rigido e polistirene, PVC/CV e altri materiali in ambienti asciutti.



BODENKLEBER CLASSIC

Cod. art.	1187	1188
Formato	Kg.4	Kg.25



PROFI - EINSEITKLEBER

COLLA UNIVERSALE PROFESSIONALE

E' indicata per incollare rivestimenti in PVC/CV in strisce e piastrelle, moquette con diverso materiale di supporto e feltro. (Incolla anche PVC su PVC).



PROFI EINSEITKLEBER

Cod. art.	1184	1185	1186
Formato	Gr.750	Kg.5	Kg.10



MONTAGE UNIVERSALKLEBER

COLLA UNIVERSALE PER MONTAGGIO

Colla forte per incollare legno, polistirolo, piastrelle da parete in ceramica, sughero, rivestimenti per parete in PVC e schiuma di lattice, decorativi e isolanti.



MONTAGE UNIVERSALKLEBER

Cod. art.	1180	1182
Formato	Gr.750	Kg. 6



METYLAN SAXIT

COLLA UNIVERSALE

Colla acrilica per l'incollaggio di piastrelle in ceramica e mosaico, fogli in PVC rigido, polistirolo gofrato e sughero Schiuma di lattice e battiscopa.



METYLAN SAXIT

Cod. art.	1031	1032	1033
Formato	Gr.900	Kg.4	Kg.6



STYROPOR KLEBER

COLLA PER POLISTIROLO

Colla a dispersione acquosa pronta all'uso per polistirolo ed espansi rigidi. Per incollare pannelli a soffitto, sotto tappezzerie, pannelli isolanti (esempio Pufatherm) e modanature per interni.



Cod. art.	1170	1172	1173
formato	Kg.1	Kg.7	Kg.14



KORKKLEBER

COLLA PER SUGHERO

La Colla per sughero decotric è particolarmente indicata per l'incollaggio di pannelli parietali, supporti e sotto tappezzerie in sughero. Non è indicata per incollare sughero per pavimenti.



Cod. art.	1165
Formato	Kg.8



ADEFIX 3073

COLLA/INTONACO DI MONTAGGIO

Colla di montaggio per cornici NMC ADEFIX Noel Marquet collante acrilico forte a base d'acqua per installazione interna giunture riempitivo come stucco.



Cod. art.	1117
formato	ml.310



TAPETEN ABLÖSER

Rimuove in modo rapido e semplice tutti i tipi di carte da parati e fibre ruvide.

- concentrato altamente efficace



Cod. art.	1045
formato	ml.250



VLIES & GEWEBE KLEBER GK

COLLA PER FIBRA DI VETRO E TNT

La Colla GK per fibra di vetro e TNT decotric è particolarmente indicata per fibra ruvida, TNT da restauro e armatura, rivestimenti pesanti nonché tessuto in fibra di vetro (accoppiato e non).



VLIES & GEWEBE KLEBER GK



Cod. art. 1065
formato Gr.500



SPEZIALKLEISTER MC

COLLA PER CARTA DA PARATI

Colla a base di metilcellulosa, di ottima qualità e rapidamente solubile. Per incollare carte da parati strutturate, goffrate, in fibra ruvida, tessuti e viniliche nonché tutti i rivestimenti pesanti.



SPEZIALKLEISTER MC



Cod. art. 1063
formato Gr.200



POWER SPECIAL NON WOVEN TNT

Per carte da parati in tessuto non tessuto, vinile, tessuto e carta pesante.

- contiene metilcellulosa
- rinforzato con resina
- pronto in 30 minuti



POWER SPECIAL NON WOVEN



Cod. art. 1060
formato Gr.200



POWER UNIVERSAL PINK

Colla con controllo integrato dell'applicazione per carta da parati vinilica, strutturata, goffrata e in TNT nonché per altre carte da parati pesanti.

- con indicatore visibile per il controllo dell'applicazione
- trasparente da asciutta



POWER UNIVERSAL PINK



Cod. art. 1064
formato Gr.250



POWER NORMAL KLEBER

Per carta da parati leggera. Con metilcellulosa



POWER NORMAL KLEBER

Cod. art. 1052

formato Gr.125



POWER UNIVERSAL KLEBER

Colla per impiego universale indicata per carta da parati vinilica, strutturata, gofrata e in TNT nonché per altre carte da parati pesanti.



POWER UNIVERSAL KLEBER

Cod. art. 1054

formato Kg.10



ADHESIVA TNT

A base di resine sintetiche in polvere.
Per rivestimenti murali vinilici con supporto in tessuto non tessuto.



ADHESIVA TNT

Cod. art. 1062

Formato Gr.250



METYLAN SPECIAL VIOLA

A base di metilcellulosa, per l'incollaggio di parati pesanti, vinilici.
In polvere.



METYLAN SPECIAL VIOLA

Cod. art. 1061

Formato Gr.180



METYLAN SICHOSZELL

A base di metilcellulosa
Per l'incollaggio di parati leggeri e sottoparati



METYLAN SICHOSZELL

Cod. art. 1050

Formato Gr.125





Linea Sigillanti

- Siliconi
- Schiume poliuretaniche
- Pulitori per schiuma
- Tassello chimico



AKFIX 965

SCHIUMA POLIURETANICA

Ideale per tegole e coppi
Adesione in sole 2 ore
Resa 14 m² di tegole
Classe antincendio B2 - DIN 4102
Utilizzabile a basse temperature



AKFIX 965



Cod. art. 1026

Formato ml.750



AKFIX 805M

SCHIUMA POLIURETANICA

Monocomponente
Autoespandente
Ideale per riempimento
Rende fino a 45 litri
Classe antincendio B3 - DIN4102-1
Resiste alla muffa, sovra verniciabile
Utilizzo manuale



AKFIX 805M



Cod. art. 1023

Formato ml.750



AKFIX 805P

- ✓ Monocomponente
- ✓ Autoespandente
- ✓ Ideale per riempimento
- ✓ Rende fino a 45 litri
- ✓ Classe antincendio B3
- ✓ Resiste alla muffa
- ✓ Sovra verniciabile
- ✓ Utilizzo con pistola



AKFIX 805P



Cod. art. 1024

Formato ml.750



AKFIX C900

- ✓ Resina a iniezione bicomponente
- ✓ A rapido indurimento
- ✓ Ideale per fissaggio su calcestruzzo, mattoni forati.
- ✓ 2 cannucce in dotazione.



PULITORE SCHIUMA PU

- ✓ Rimuove la schiuma fresca
- ✓ Pulisce la pistola
- ✓ Pulisce le superfici
- ✓ Pulisce finestre e serramenti



PULITORE SCHIUMA PU

Cod. art. 1025

Formato ml.500



AKFIX C900

Cod. art. 1118

Formato ml.300

AKFIX AC605

SIGILLANTE ACRILICO

- ✓ Per materiali porosi
- ✓ Per giunti tra telai di finestre
- ✓ Per la riparazione di crepe



AKFIX AC605



Cod. art. **0921**

Formato ml.310

CAPEC AC86

SIGILLANTE ACRILICO

- ✓ Per sigillare materiali porosi
- ✓ Per giunti tra telai di finestre
- ✓ Per la riparazione di crepe



CAPEC AC86



Cod. art. **0920**

Formato ml.310

AKFIX 100E

SILICONE UNIVERSALE

- ✓ Per sigillare materiali non porosi
- ✓ Elastico, Antimuffa
- ✓ **Cartuccia ml.280**



AKFIX 100E

Cod. art. **0404**

Colore Testa di moro

0405

Grigio

0406

Avorio

0407

Nero

0410

Trasparente

0411

Bianco



AKFIX 100E BLISTER

SILICONE UNIVERSALE

- ✓ Per sigillare materiali non porosi
- ✓ Elastico, Antimuffa
- ✓ **Tubetto ml.50**



Cod. art.

0475

Trasparente

0480

Bianco



AKFIX 100E

AKFIX 900N

SILICONE NEUTRO

- ✓ Per l'incollaggio di specchi
- ✓ Altamente elastico
- ✓ Senza solventi
- ✓ Resistente da -60° a +180°
- ✓ **TRASPARENTE**



Cod. art. **0415**

Formato ml.310

AKFIX UNIVERSAL

SIGILLANTE ADESIVO

- ✓ A base di MS di qualità
- ✓ Senza solventi
- ✓ Non forma bolle
- ✓ Resistente ai raggi UV
- ✓ Verniciabile
- ✓ Aderisce senza primer
- ✓ **BIANCO**



Cod. art. **1112**

Formato ml.290

PATTEX SP101

SIGILLANTE ADESIVO

- ✓ Aderisce senza primer
- ✓ Resistente alle intemperie
- ✓ Verniciabile
- ✓ Applicato anche su bagnato
- ✓ **Cartuccia ml.280**



Cod. art. **1110**

Colore Bianco

1111

Trasparente

SEALSTICK SIGILLANTE

- ✓ A base di gomma butilica
- ✓ A sezioni piatte
- ✓ Resistente all'acqua
- ✓ Per sigillature fra metalli diversi
- ✓ Per vetri
- ✓ Serramenti
- ✓ Legno
- ✓ Top cucina
- ✓ Sezione mm.10 x 2
- ✓ 180 m/l su 6 file



Cod. art. **0817**

Modello Rotolo

Cod. art. **0818**

Blister Metri 2,3





Incollaggio per Fai da te

- Viniliche
- Acriliche per montaggio
- Termofusibile
- Neopremiche
- Epossidiche
- Poliuretaniche
- Cianoacriliche



PATTEX VINILICA EXPRESS

Colla vinilica a rapida essiccazione
Per l'incollaggio su tutti i tipi di legno e derivati
Perfettamente trasparente una volta asciutto
Classe D2 secondo DIN EN 204



PATTEX VINILICA EXPRESS

Cod. art.	1019.50	1019.51	1019.52
formato	Gr.75	Gr.250	Gr.750

PATTEX VINILICA UNIVERSALE

Adesivo vinilico plastico trasparente
Ideale per carta, sughero, materiali porosi, legno
Utilizzabile come fissativo per pitture e stucchi



PATTEX VINILICA UNIVERSALE

Cod. art.	1620	1621	1640	1641
formato	Gr.100	Gr.250	Kg.1	Kg.5

PATTEX PARQUET

A base vinilica
Ideale per la posa di pavimenti in legno



PATTEX PARQUET

Cod. art.	1189
Formato	Kg.5

PATTEX MILLE CHIODI

A base d'acqua
Ideale per zoccolini, pannelli decorativi, legno,
Metallo, ceramica, pvc e sughero



PATTEX MILLE CHIODI

Cod. art.	1100	1101	1102
formato	Gr.100	Gr.250	Gr.460

MONTAGE KLEBER

Adesivo potente per interni.
Per l'incollaggio rapido e sicuro di legno, polistirolo, piastrelle per pareti in ceramica, rivestimenti murali in schiuma di PVC e materiali simili.



Cod. art. 1179

Formato Gr.300

MONTAGE KRAFTKLEBER FIX

Per modelli di modanature, battiscopa, rivestimenti in legno, pannelli, listelli in legno e PVC, pannelli decorativi e isolanti, rivestimenti in ceramica, ecc.
Per incollaggi sicuri su legno, cemento, intonaco, pietra, metallo e superfici simili.



Cod. art. 1115

Formato ml.280

KONSTRUKTION KLEBER

Adesivo extra forte per materiali e superfici assorbenti e non assorbenti ad esempio piastrelle smaltate, metallo, specchi, vetro, ceramica, PVC, polistirolo, legno, pietra, intonaco, superfici laccate.

TRASPARENTE



Cod. art. 1116

Formato Gr.300

ACRYLIC MONTAGE ADHESIVE

Akfix 310 è un adesivo a base d'acqua utilizzato per l'incollaggio di numerosi materiali da costruzione. È particolarmente adatto per gli utenti fai-da-te grazie al contenuto privo di solventi e all'elevata forza di adesione.



Cod. art. 1105

Formato ml.310

KIND STICK WICOLLA

Aceto vinilica trasparente.
Formula speciale per aderire su polistirolo.



Cod. art.	0930	0931	0932
formato	Gr.100	Gr.200	Gr.450

DECOCOLL EXPRESS LEIM

Colla a presa rapida vinilica
Per l'incollaggio di profili in legno
e lavori di bricolage



Cod. art.	1020
formato	Gr.500

D3 SUPER WOOD GLUE

Adesivo di acetato di polivinile.
Resistente all'acqua.
Per legno, pronto all'uso.



Cod. art.	1655
formato	Kg.1

VINILCAPEC

È un adesivo in dispersione acquosa vinilica
Risponde ai requisiti della norma EN 204 gruppo D2



Cod. art.	1650	1652	1653	1654
formato	Gr.100	Kg.1	Kg.5	Kg.25

COLLA TERMOFUSIBILE



Cod. art.	0906 N	0906 T	0907	0906 M
formato	Ø12 nera Kg.1	Ø 12 trasparente Kg.1	Ø 8 trasparente Kg.1	Ø12 miele Kg.1

PISTOLA A CALDO



Cod. art.	1010	1011
Modello	10 watt x Ø8	40 watt x Ø12

PATTEX ACCIAIO LIQUIDO

Adesivo epossidico bicomponente
Di colore metallico
Resistente al calore e all'acqua
Regge fino a 130 kg/cm²



Cod. art. 1087

Formato 2 x 15 gr.



PATTEX SALDATUTTO

Adesivo epossidico bicomponente
Di colore trasparente
Resistente al calore fino a 80° e all'acqua
Reagisce in 5 minuti



Cod. art. 1086

Formato 2 x 15 gr.



ARTIGLIO FLASH STICK

Adesivo cianoacrilato istantaneo.
Trasparente.
Agisce in pochi istanti



Cod. art. 0926

Formato Gr.3



CAPEC Istant

Adesivo cianoacrilato istantaneo professionale.
Trasparente, agisce in pochi istanti



Cod. art. 0815

Formato Gr.20



0816

Formato Gr.50

AKIFIX 610 EXPRESS PU

Adesivo poliuretano monocomponente
Resistente all'umidità
D4 waterproof



Cod. art. 1104

Formato ml.50



AKIFIX PA360

Adesivo poliuretano D4
Monocomponente che polimerizza
con l'aria.
Resistente all'acqua D4-DIN EN204



Cod. art. 1121

Formato Gr.560



PATTEX CONTACT TRASPARENTE

Adesivo a contatto trasparente.

Ideale per materiali come pelle, cuoio, legno, carta e cartone, materie plastiche flessibili
Esclusi PE, PP e PTFE



PATTEX CONTACT TRASPARENTE

Cod. art. **1003** **1004**

Formato Gr.50 Gr.125

PATTEX CONTACT UNIVERSAL

Adesivo a contatto universale.

Ideale per l'incollaggio di gomma, cuoio, moquette, feltro, sughero, metallo, legno ect



PATTEX CONTACT UNIVERSAL

Cod. art. **1008** **1009**

Formato Gr.50 Gr.125

ARTIGLIO SUPER 620

Adesivo neopremico.

Ideale per cuoio, feltro, sughero, legno e plastica.



ARTIGLIO SUPER 620

Cod. art. **0940** **0941**

Formato ml.500 ml.1000

ARTIGLIO SUPER 620 GLUE

Adesivo neopremico.

Ideale per cuoio, feltro, sughero, legno e plastica.



ARTIGLIO SUPER 620 GLUE

Cod. art. **0938** **0939**

Formato ml.75 ml.150

ARTIGLIO SUPER CHIARO

Adesivo neopremico trasparente.

Adatto per incollare ogni superficie ruvida come legno, plastica e cuoio



ARTIGLIO SUPER CHIARO

Cod. art. **0937** **0934** **0935**

Formato ml.25 ml.50 ml.125

ZPREN 2000

Adesivo a base di policloroprene.

Per l'incollaggio di laminati plastici, compensato, metallo, cuoio, tessuto.

Resistente all'acqua



ZPREN 2000

Cod. art. **1001**

Formato Gr.850



Nastri adesivi Universali

- Nastri in carta
- Imballaggio
- Biadesivi telati
- Biadesivi spessorati
- Telati
- Isolanti
- Autofondenti



NASTRO CARTA CAPEC MASK

- ✓ Colore giallo
- ✓ Spessore 131 µm
- ✓ Resistenza termica: 100°C/60 min
- ✓ Tempo di rimozione: 5 giorni (interno)
- ✓ **Rotoli da YD 50**

CAPEC
WORK PROJECT



NASTRO CARTA CAPEC MASK

Cod. art.	6460	6461	6462	6463	6464	6465	6466
misura	mm 12	mm 19	mm 25	mm 30	mm 38	mm 50	mm 100

NASTRO CARTA CAPEC MASK 2

- ✓ Colore avorio
- ✓ Spessore 132 µm
- ✓ Resistenza termica: 60°C
- ✓ Tempo di rimozione: 5 giorni (interno)
- ✓ **Rotoli da YD 50**

CAPEC
WORK PROJECT



NASTRO CARTA CAPEC MASK 2

Cod. art.	64551	64552	64553	64554	64555
misura	mm 18	mm 24	mm 30	mm 36	mm 48

NASTRO CARTA MASK BLU

- ✓ Colore blu
- ✓ Spessore 147 µm
- ✓ Adesione al metallo: 240g/cm
- ✓ Resistenza termica: 120°C
- ✓ Tempo di rimozione: 15 giorni (interno) 10 giorni (esterno)
- ✓ **Rotoli da 50 metri**



NASTRO CARTA MASK BLU



Cod. art.	64672	64674	64675
misura	mm 25	mm 38	mm 50

NASTRO CARTA MASK VIOLA

- ✓ Colore viola, bassa forza adesiva
- ✓ Può essere rimosso anche dopo 60 giorni
- ✓ Per eseguire linee di precisione
- ✓ **Misura in MT**



NASTRO CARTA MASK VIOLA



Cod. art. **64680**

misura mm 25X50



NASTRO CARTA MASK GIALLO

- ✓ Colore giallo per interni/esterni
- ✓ Spessore 147 µm. Resistenza termica: 100°C/60 min
- ✓ Resistenza UV fino a 7 giorni
- ✓ Per lavori di bordatura
- ✓ **Misura in MT**



NASTRO CARTA MASK GIALLO



Cod. art. **64685** **64687**

misura mm 25X45 mm 48X45



NASTRO CARTA CRESMATO PER CURVATURE

- ✓ Colore brown
- ✓ Per applicazioni di interno come decorazioni, stencil
- ✓ Permette di essere curvato e rimosso fino a 7 giorni
- ✓ **Misura in MT**



NASTRO CARTA MASK CRESMATO



Cod. art. **64689**

misura mm 25X50



NASTRO CARTA REMOVIBILE LOW TACK

- ✓ Colore AVORIO, a bassa adesività.
- ✓ Ideale per l'applicazione su superfici già verniciate
- ✓ Ottimo per decorazioni, stencil
- ✓ Rimozione consigliata entro le 60 ore
- ✓ **Misura in MT**



NASTRO CARTA REMOVIBILE LOW TACK



Cod. art. **64677**

misura mm 25X50



TESA® 4347 ESSENTIAL

- ✓ Nastro carta leggermente crespata in gomma naturale
- ✓ Per applicazioni di mascheratura
- ✓ Spessore 120 µm
- ✓ **Rotoli da 45 metri**



TESA® 4347 ESSENTIAL



Cod. art.	64501	64502	64503	64504	64505
-----------	-------	-------	-------	-------	-------

misura	mm 18	mm 24	mm 29	mm 36	mm 48
--------	-------	-------	-------	-------	-------

TESA® 4333 PRECISION MASK

- ✓ Nastro carta Colore Pink
- ✓ Spessore 80 µm
- ✓ Adatto per superfici delicate
- ✓ **Rotoli da 50 metri**



TESA® 4333 PRECISION MASK



Cod. art.	64510	64511	64512	64513	64514
-----------	-------	-------	-------	-------	-------

misura	mm 19	mm 25	mm 30	mm 38	mm 50
--------	-------	-------	-------	-------	-------

TESA® 4435 UV PAPER TAPE

- ✓ Nastro carta Colore blu
- ✓ Spessore 145 µm
- ✓ **Rotoli da 50 metri**



TESA® 4435 UV PAPER TAPE



Cod. art.	64520	64521	64524
-----------	-------	-------	-------

misura	mm 19	mm 25	mm 50
--------	-------	-------	-------

MASKING 255 SYROM

- ✓ Nastro carta Colore Pink
- ✓ Spessore 75 µm
- ✓ **Rotoli da 50 metri**



MASKING 255 SYROM



Cod. art.	64530	64531	64532	64533	64534
-----------	-------	-------	-------	-------	-------

misura	mm 19	mm 25	mm 30	mm 38	mm 50
--------	-------	-------	-------	-------	-------

NASTRO IMBALLO SILENT

Prodotto a solvente, silenzioso
Spessore 35 micron
Ad uso imballaggio
Misura: mm. 50 x 66 metri



NASTRO IMBALLO SILENT

Cod. art.	6455 A	6455 B	6455 T
-----------	--------	--------	--------

Colore	Avana	Bianco	Trasparente
--------	-------	--------	-------------



NASTRO IMBALLO ECO

In polipropilene
Collante a solvente
Spessore 23 micron
Misura: mm. 50 x 50 metri



NASTRO IMBALLO ECO

Cod. art.	64549
-----------	-------

Colore	Avana
--------	-------



PISTOLA NASTRATRICE

Con protezione sicura, facile da usare
Tensione del nastro regolabile
Indispensabile per l'imballaggio di scatole



PISTOLA NASTRATRICE

Cod. art.

6468



NASTRO ADESIVO TRASPARENTE

In PPL
Buona trasparenza
Aderisce su tutte le superfici
Misura: 66 metri



NASTRO ADESIVO TRASPARENTE

Cod. art.	3352	3353
-----------	------	------

misure	mm.15	mm.19
--------	-------	-------



BIADESIVO EXTRAFORTE

Nastro biadesivo con supporto in schiuma PE bianca a celle chiuse 1 mm di spessore, dotato di un adesivo acrilico a solvente. Ideale per l'accoppiamento e per il montaggio di diversi materiali come vetro, specchi, legno, gomma, plastica, metalli ecc...



Cod. art.	6469.03	6469.01
misura	mm.19 x 5 mt	mm.19 x 1,5 mt

BIADESIVO BRICOLAGE

Nastro biadesivo con supporto in Poliestere trasparente 0,09 mm di spessore, dotato di un adesivo acrilico a solvente. Prodotto indicato per applicazioni generali, aderisce molto bene su carta, cartone e derivati.



Cod. art.	6469.05
misura	mm.15 x 10 mt

BIADESIVO FORTISSIMO EXTRA SOTTILE

Nastro biadesivo con supporto in Poliestere trasparente 0,20 mm di spessore, dotato di un adesivo acrilico a solvente modificato ad elevate prestazioni.



Cod. art.	6469.04
misura	mm.19 x 5 mt

BIADESIVO FORTISSIMO ACRILICO

Nastro biadesivo in schiuma acrilica trasparente 0,50 mm di spessore, dotato di una massa viscoelastica adesiva acrilica ad elevate prestazioni, in grado di sostituire viti e rivetti.



Cod. art.	6469.02
misura	mm.19 x 1,5 mt

BIADESIVO MOUNTING UNIVERSAL



Nastro in schiuma acrilica bianca
Ideale per accoppiamento e incollaggio di vetro, legno, plastica, metallo.

Colore	bianco
Colore del liner	giallo
Massa adesiva	gomma sintetica
Peso del liner	80 g/m ²
Spessore del liner	70 µm
Spessore totale	1.050 µm
Supporto	schiuma di PE
Tipo di liner	carta siliconata



Cod. art.

64528

misure

mm.19 x 5 mt



BIADESIVO MOUNTING PRO MIRROR



Supporto in PVC plastificato bianco
Molto usato per montaggio di specchi in ambienti umidi
Regge anche su piastrelle del bagno

Colore	bianco
Colore del liner	bianco con logo rosso
Massa adesiva	gomma sintetica
Spessore totale	1.150 µm
Supporto	schiuma di PE



Cod. art.

64526

64527

misure

mm.19 x 1,5 mt

mm.19 x 5 mt



BIADESIVO PRO MOUNTING



Nastro in schiuma acrilica bianca
Per uso interno/esterno
Sostiene 10 kg. Con 10 cm di nastro

Colore	bianco
Colore del liner	marrone
Massa adesiva	acrilico modificato
Peso del liner	80 g/m ²
Spessore del liner	70 µm
Spessore totale	1.150 µm
Supporto	schiuma di PE
Tipo di liner	carta siliconata



Cod. art.

64529

misure

mm.19 x 1,5 mt



NASTRO BIADESIVO UNIVERSALE

Supporto in PVC plastificato bianco

Molto usato per ancorare al pavimento moquette linoleum e pavimenti sintetici



Cod. art.	6459	6458
misure	mm.50 x 5 mt	mm.50 x 25 mt



NASTRO BIADESIVO TELATO

Supporto in PVC retinato plastificato bianco

Molto usato per ancorare al pavimento moquette, linoleum e pavimenti sintetici



Cod. art.	6456	6457
misure	mm.50 x 5 mt	mm.50 x 25 mt

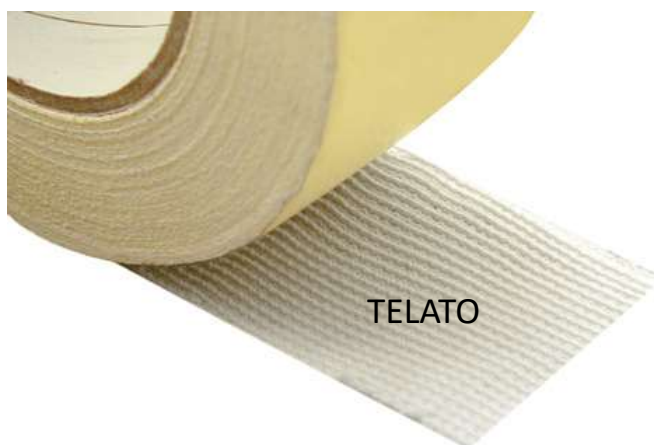

NASTRO ADESIVO IN ALLUMINIO

Utilizzato per giunte su materiali isolanti.
Resistente ai raggi UV, alle alte temperature.



Cod. art.	1080
misure	mm.50 x 10 mt



NASTRO AUTOFONDENTE

Nastro di gomma di silicone.
Resistente all'umidità.
Resiste a -50° a + 260 gradi
Isolante a 8.000 Volt
Si allunga del 300%



Cod. art.	3380
misure	cm.3 x 3 mt



NASTRO ADESIVO TELATO DUCT TAPE

Colore ARGENTO
 Per imballaggio, sigillatura e altri scopi.
 Resistente alla trazione e alla rottura.



NASTRO ADESIVO TELATO DUCT TAPE

Cod. art.	1081	1082
misura	mm 50 X 10 mt	mm 50 x 25 mt



NASTRO ADESIVO TELATO DUCT TAPE

Colore VARI
 Molto versatile
 Per imballaggio, sigillatura e altri scopi
 Resistente alla trazione e alla rottura
 Misura mm.50 x 25 metri



NASTRO ADESIVO TELATO DUCT TAPE

Cod. art.	10821	10822	10823	10824	10825	10826
misura	Nero	Bianco	Blu	Giallo	Rosso	Verde



NASTRO ADESIVO TELATO MULTIUSO

Utile in casa, ufficio, scuola.
 Per la rilegatura di libri o fascicoli.
 Colori disponibili:
 argento – bianco – blu - marrone – nero – rosso - verde



NASTRO ADESIVO TELATO MULTIUSO

Cod. art.	3361
misura	mm 38 x 2,7 metri



NASTRO ADESIVO TELATO MULTIUSO

Utile in casa, ufficio, scuola.
 Per la rilegatura di libri o fascicoli.
 Colori disponibili:
 argento – bianco – blu - marrone – nero – rosso - verde



NASTRO ADESIVO TELATO MULTIUSO

Cod. art.	3360
misura	mm 19 x 2,7 metri



NASTRO ISOLANTE PVC ELETTRIC

Molto usato per l'isolamento di cavi elettrici

Misura: mm.15 x 10 metri



Cod. art. 3370N 3370R 3370B

Colore Nero Rosso Bianco



NASTRO ISOLANTE PVC ELETTRIC

Molto usato per l'isolamento di cavi elettrici

Misura: mm.19 x 25 metri



Cod. art. 3371N 3371B

Colore Nero Bianco



NASTRO ISOLANTE PVC ELETTRIC

Molto usato per l'isolamento di cavi elettrici

Misura: mm.25 x 25 metri



Cod. art. 3373

Colore Nero



NASTRO ISOLANTE PVC ELETTRIC

Molto usato per l'isolamento di cavi elettrici

Misura: mm.50 x 25 metri



Cod. art. 3374

Colore Nero



NASTRO TEFLON PTFE

Nastro professionale in teflon 100% PTFE.

Rotolo: 12 mm x 10 mt (in blister 3 pezzi) Spessore: 0,20 mm.



Cod. art. 3372

Colore Bianco





Mascheratura & protezione

- Carta per mascheratura
- Polietilene per mascheratura
- Carta paparella
- Dispencer per carta
- Macchinetta per paparella
- Teli copritutto
- Foglia polietilene
- Feltro assorbente
- Cartoni mono onda/ondulati
- Pellicola estensibile
- Teli occhiellati



CARTA PER MASCHERATURA CAPEC

Rotolini di carta accoppiati con nastro carta da 22 mm
Rotoli da metri 20



Cod. art.	6545.10	6545.18	6545.30
Misura	cm. 10	cm. 18	cm. 30



POLIETILENE PER MASCHERATURA CAPEC

Rotolini di polietilene accoppiati con nastro carta da 22 mm
Lunghezza carta dei rotoli in metri



Cod. art.	6547	6547.110	6549
Misura	cm.55 x 20	cm.110 x 20	cm. 140 x 20

Cod. art.	6549.180	6549.210	6549.240	6549.270
Misura	cm. 180 x 20	cm. 210 x 20	cm.240 x 20	cm.270 x 16



CARTA PER PAPARELLA

Carta in bobina per mascherature.
Di alta qualità con basso grado di porosità.
Peso 40 gr/m²



Cod. art.	6570	6571	6572	6573
Misura	cm. 15	cm. 30	cm. 45	cm. 85



DISPENCER PER POLIETILENE

Per rotolini accoppiati
Con lama metallica da taglio inclusa



Cod. art.	6546
Modello	cm. 10
	6548
	cm. 20



MACCHINETTA INCARTATRICE



Cod. art.	6599	6598
Modello	3 lame cm. 15/30/45	1 lama cm.30

TELO COPRITUTTO MULTIUSO

In polietilene mt. 4 x 4 per proteggere pavimenti, e mobili da polvere, vernice e altro.



TELO COPRITUTTO MULTIUSO

Cod. art.	4422	4423	4424	4427	4428
Peso	Gr.200	Gr.400	Gr.730	Gr.1100	Gr.1500



TELO COPRITUTTO BASIC

In HDPE
Mt. 4 x 4



TELO COPRITUTTO BASIC

Cod. art.	Peso
4426	Gr. 110



TELO COPRITUTTO MAXI

In polietilene mt. 4 x 25
Spessore 7 micron
trasparente



TELO COPRITUTTO MAXI

Cod. art.	4425	44251
Peso	Gr.1150	Gr.670



FOGLIA TAKE AWAY

Polietilene rigenerato
Piegato a 50 cm.
antiscivolo



FOGLIA TAKE AWAY

Cod. art.	44291	44290
Formato	4 x 10 metri	2 x 20 metri



FELTRO ASSORBENTE IN ROTOLO

Termofuso antiscivolo, tipo extra pesante
Gr.220



Cod. art. 6574 65741

Modello H.100 x 25 mt H.100 x 10 mt



CARTONE COPRI PAVIMENTO EXTRA

Extra pesante
In rotolo onda singola



Cod. art. 65615

Modello H.100 x 45 mt



CARTONE COPRI PAVIMENTO CON BUSTA

180 gr. ca. In rotolo onda singola.
Confezionati in busta singola



Cod. art. 6563 65645

Modello H.100 x 16 mt H.100 x 45 mt



CARTONE COPRI PAVIMENTO

180 gr. ca.
In rotolo onda singola



Cod. art. 6564

Modello H.100 x 45 mt



CARTONE ONDULATO COPRI PAVIMENTO

250 gr. ca.
In rotolo onda a nido d'api



Cod. art. 6568 6569

Modello H.100 x 20 mt H.100 x 45 mt



SCATOLA PER IMBALLI

250 gr. a nido d'api



SCATOLA PER IMBALLI

Cod. art. 6567

Modello H.36 – L.42 x 43



FILM PELLICOLA ESTENSIBILE

Pellicola protettiva, elastica e resistente



FILM PELLICOLA ESTENSIBILE

Cod. art. 3993

3999

Modello Trasparente
cm 50 x 300 mt

Trasparente
cm 12 x 150 mt



FILM PELLICOLA ESTENSIBILE

Pellicola protettiva
Elastica e resistente
Misura H cm.50 x 300 metri



FILM PELLICOLA ESTENSIBILE

Cod. art. 3993 N

Modello Nera



PLURIBOLL FILM BOLLE ARIA

Più conosciuto e più versatile per la protezione da urti, graffi e vibrazioni



PLURIBOLL FILM BOLLE ARIA

Cod. art. 4413

4417

4414

Modello Gr.55
cm. 100 x 80 mt

Gr.55
cm. 100 x 10 mt

Gr. 90
cm. 100 x 80 mt



TELO OCCHIELLATO RINFORZATO

Peso 200 gr/mq, in polietilene, impermeabile e lavabile.
Stabilizzato ai raggi UV con angoli rinforzati e cordino di rinforzo perimetrale
Colore grigio/argento

Misure in metri



TELO OCCHIELLATO RINFORZATO

Cod. art.	7320	7321	7322	7323	7324
Misure	3 x 4	5 x 4	6 x 5	8 x 6	8 x 10



TELO OCCHIELLATO RETINATO

Peso 130 gr/mq, colore trasparente con trama di rinforzo bianca.
Materiale PVC, resistente all'acqua con occhielli e bordo rinforzato.

Misure in metri



TELO OCCHIELLATO RETINATO

Cod. art.	7340	7341	7342	7343
Misure	3 x 2	3 x 4	4 x 5	4 x 6



TELO OCCHIELLATO VERDE BLU

Peso 80 gr/mq, colore verde/blu, materiale PVC.
Resistente all'acqua, con occhielli e bordo rinforzato.

Misure in metri



TELO OCCHIELLATO VERDE BLU

Cod. art.	7331	7332.34	7332.45	7332.58	7334
Misure	3 x 2	3 x 4	4 x 5	6 x 8	6 x 10



TELO ANTIPIOGGIA

Peso 280 gr
Colore trasparente
Materiale LDPE
Resistente all'acqua
Spessore 50 micron

Misure in metri

Cod. art.	4421
Misura	3 x 2





Accessori per tappezzieri

- Tavoli
- Dima per taglio
- Spatole
- Spazzole
- Rullini premigiunto
- Raschietti
- Divisorio anti polvere
- Cutter
- Lame
- Forbici



**TAVOLI DA TAPPEZZERIA
Professionali**

- ✓ Tavolo con prolunghe pieghevoli
- ✓ Spessore del compensato mm.5
- ✓ Altezza piano di lavoro cm. 84

4201 - Piano di lavoro aperto cm.75 x 3 metri
✓ **Peso kg. 21,50**

4203 - Piano di lavoro aperto cm.100 x 3 metri
✓ **Peso kg. 24,50**

Cod. art.	misura
4201	cm.75 x 3 mt
4203	cm. 100 x 3 mt



TAVOLI DA TAPPEZZERIA

- ✓ Tavolo con prolunghe pieghevoli
- ✓ Piano di lavoro in alluminio graduato
- ✓ Altezza piano di lavoro cm. 84
- ✓ Piano di lavoro aperto cm.60 x 300 metri



Cod. art.
4199



DUST PROF – KIT ANTIPOLVERE

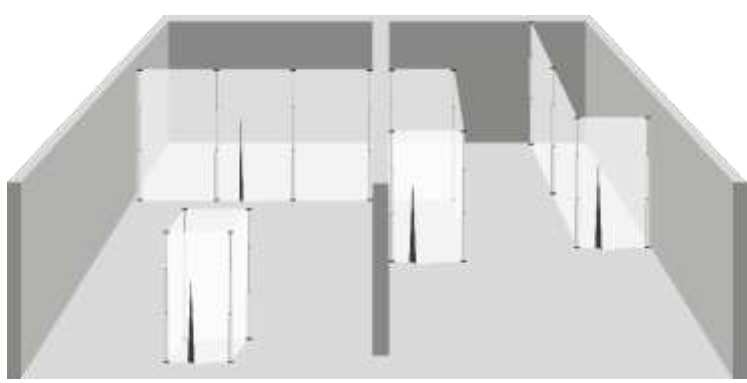

- ✓ Sistema antipolvere che permette di separare lo spazio di lavoro dal resto della stanza, impedendo la fuoriuscita di polvere.

- Contenuto del kit:
- ✓ 1 pellicola 4 x 5 metri
 - ✓ 4 pali telescopici H. cm. 3,90 max
 - ✓ 12 clips large
 - ✓ 8 clips small
 - ✓ 1 cerniera autoadesiva
 - ✓ 1 borsa per il trasporto

Cod. art.
4410

DIMA PER TAGLI OBLIQUI

In legno MDF
 H = cm.12
 L = cm. 44
 W = cm. 12
 Taglio 45° e 90°

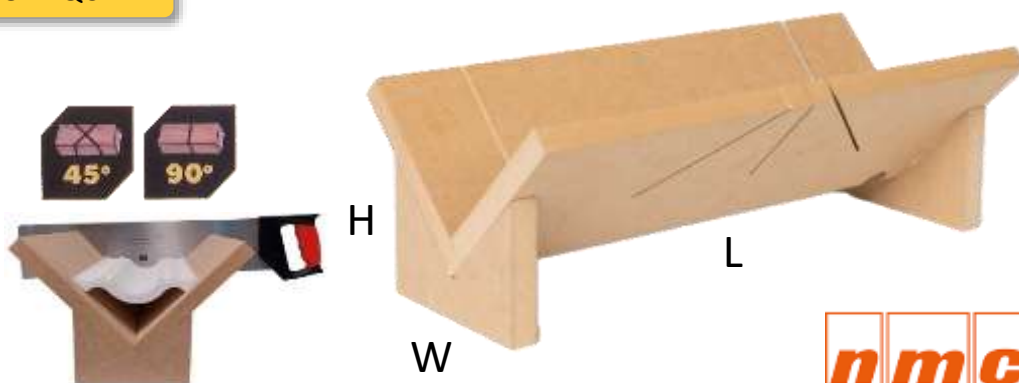

Cod. art.

4375



4375



SCATOLA DIMA E SEGA

In materiale ABS, misura cm.30 x 14 x 7
 Taglio guidato a 45° e 90° con segaccio da cm.30



SCATOLA DIMA E SEGA

Cod. art.

4377

misura

Dima + segaccio

4384

Segaccio

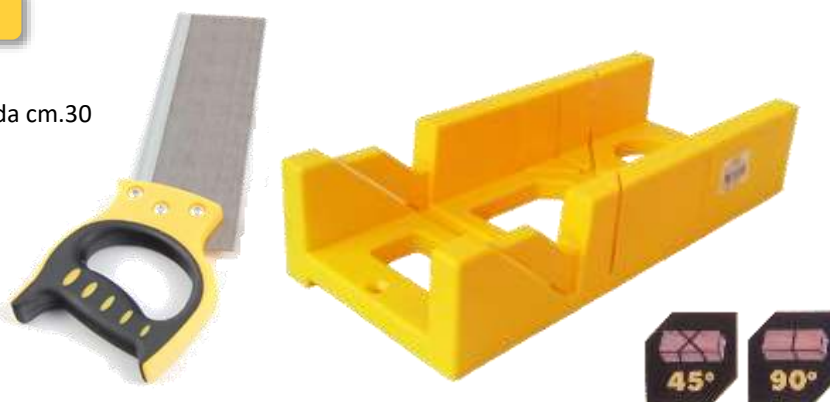

DIMA PER CORNICI

In plastica
 H = mm.122
 L = mm. 322
 W = mm. 150
 Altezza taglio mm. 102
 Con fori per il fissaggio su banco



Cod. art.

4376



4376

DIMA PER CORNICI

In plastica
 H = mm.49
 L = mm. 247
 W = mm. 78
 Altezza taglio mm. 30
 Con sega da mm. 250
 Con fori per il fissaggio su banco

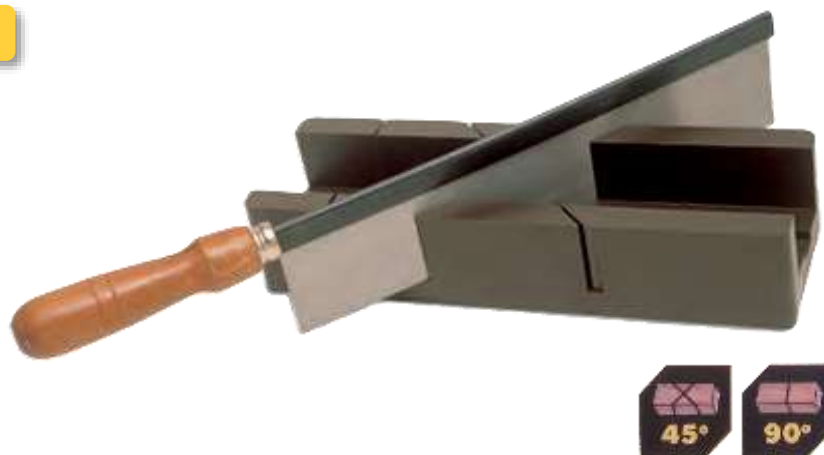

Cod. art.

4371



4371

Lama rigida a raschietto



Cod. art.	misura
5180	cm. 7



Manico in gomma morbida
Lama a 15 funzioni



Cod. art.	misura
5181	cm.7,6



Manico in gomma morbida
Lama intercambiabile



Cod. art.	misura
5003	Lama cm.10



Corpo in plastica, lama riportata a trapezio
Tipo Stanley



Cod. art.	misura
5000	cm. 7



Corpo in plastica, lama riportata a trapezio.



Cod. art.	misura
5001	cm.7



Corpo in acciaio zincato, lama rivettata



Cod. art.	5375	5376
Misura	cm. 10	cm. 20



STACCAPARATI



5377

Cod. art.

5377

- Raschietto Universale
- Asta da cm. 120
- Impugnatura in gomma
- Lama da cm. 10
- Lama rivettata



6891

Cod. art.

6891

- Raschietto Universale
- Asta da cm. 60
- Impugnatura in gomma
- Lama da cm. 15
- Sostituibile



6890

Cod. art.

6890

- Raschietto Universale
- Asta da cm. 32
- Impugnatura in gomma
- Lama da cm. 10
- Sostituibile

- Spatola a lama rigida con impugnatura incorporata
- Permette di eliminare le bolle d'aria
- Di appiattire i raccordi della carta da parati

Cod. art.

4227

Misura

cm. 26 x 15



4227



- Spatola in plastica rigida con forma trapezoidale

Cod. art.

4225

Misura

cm. 24 x 12



4225



- Spatola a lama morbida in gomma
- Permette di eliminare le bolle d'aria
- Di appiattire i raccordi della carta da parati

Cod. art.

4226

Misura

cm. 20



4226



SPAZZOLA PROFI 64

- ✓ Modello piatto per parati.
- ✓ In setola nera di cavallo

Cod. art. 4220

Misura cm. 35



SPAZZOLA PROFI 41

- ✓ Modello piatto per parati
- ✓ Setola in nylon

Cod. art. 4221

Misura cm. 30



RULLINO PREMI GIUNTO

- ✓ Plastica rigida zigrinata, permette di eliminare le bolle d'aria e di appiattare i raccordi della carta da parati.

Cod. art. 4229

Misura cm. 3



RULLINO PREMI GIUNTO

- ✓ Plastica rigida liscia, permette di eliminare le bolle d'aria, di appiattare i raccordi della carta da parati.

Cod. art. 42291

Misura cm. 3



RULLINO PREMI GIUNTO

- ✓ Plastica ebanite, permette di eliminare le bolle d'aria, di appiattare i raccordi della carta da parati.

Cod. art. 4228

Misura cm. 3



CHIODINI ACCIAIO SENZA TESTA

Chiodino per cornici, in acciaio extra



Cod. art.

4300

4310

Scatola 100 pezzi mm.0,9 x 25 mm.0,9 x 21



CHIODINI ACCIAIO CON TESTA

Chiodino per cornici, in acciaio extra.



Cod. art.

4320

4321

4322

Scatola 100 pezzi mm.1,2 x 22 mm.1,2 x 25 mm.1,6 x 30



FORBICI IN TITANIO BETAKUT



Cod. art.

misura

64114

Espositore 24 pezzi
6 pezzi x misura

64110

cm.13,5

64111

cm.17,5

64112

cm.21

64113

cm.23,5



CUTTER

Cutter con corpo in metallo SX9111
 Sistema a rotella
 Guida lama interna
 Lama carbonio mm.25
 Super professionale



4034

Cod. art.

4034



Cutter con corpo in ABS CA753
 Sistema a scatto
 Guida lama interna
 Lama carbonio mm.25



4032

Cod. art.

4032



Cutter con corpo in ABS CA754
 Sistema a rotella
 Guida lama interna
 Lama carbonio mm.25
 Professionale

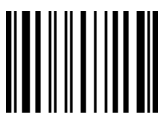

4033

Cod. art.

4033



Sistema a rotella
 Cutter con corpo in ABS
 Guida lama interna
 Lama acciaio mm.25



4031

Cod. art.

4031



CUTTER

Cutter con corpo in metallo
Sistema a scatto, guida lama interna
Lama acciaio mm.18



Cod. art.

4080



Cutter con corpo in metallo
Sistema a scatto, guida lama interna
Lama acciaio mm.9



Cod. art.

4070



Cutter con corpo in ABS Professionale
Sistema a scatto, guida lama interna
Lama carbonio mm.18



Cod. art.

4043



Cutter con corpo in plastica Professionale
Sistema a scatto, guida lama interna
Lama acciaio mm.18



Cod. art.

4045



Cutter con corpo in plastica Professionale
Sistema a scatto, guida lama interna, Lama acciaio mm.18



Cod. art.

4041



Cutter con corpo in plastica, sistema a rotella
Guida lama interna, Lama acciaio mm.18



Cod. art.

4042



Cutter con corpo in plastica, sistema a rotella
Guida lama interna, Lama acciaio mm.18



Cod. art.

63412



Con corpo in plastica, sistema a scatto
Guida lama interna, Lama acciaio mm.18



Cod. art.

4040



Con corpo in plastica, sistema a scatto
Lama acciaio mm.18



Cod. art.

4050



Con corpo in plastica, sistema a scatto
Lama acciaio mm.9



Cod. art.

4060



LAME RICAMBIO PER CUTTER

- ✓ Lame in acciaio extra
- ✓ In astucci da 10 lame



LAME LUTZ BLADES

Cod. art.	4101	4100	4106
Misura	mm.9	mm.18	mm.25



- ✓ Lame in acciaio di Titanio
- ✓ In astucci da 10 lame



LAME LUTZ BLADES TITANIO

Cod. art.	Misura
4108	mm.18



- ✓ Lame in acciaio di Carbonio
- ✓ In astucci da 10 lame



LAME LUTZ BLADES BLACK

Cod. art.	4109	4110
Misura	mm.18	mm.25



- ✓ Lame in acciaio IMPORT
- ✓ In astucci da 10 lame



LAME ACCIAIO IMPORT

Cod. art.	Misura
4103	cm.18



- ✓ Lame in acciaio Extra
- ✓ Lama a trapezio



LAME ACCIAIO TRAPEZOIDALI

Cod. art.	Misura
5015	mm.61



- ✓ Lama in acciaio extra
- ✓ In astucci da 10 lame



LAME ACCIAIO PER RASCHIETTI

Cod. art.	6895	6894
Misura	cm.10	cm.15



Accessori per pittori & cartongesso

- Secchi in plastica
- Vaschette
- Scola rullo
- Supporti porta plafoni
- Mescolatori
- Fruste
- Pertiche telescopiche
- Spatole
- Aste per lame leviganti
- Adattatori per lame leviganti
- Accessori per profili
- Biadesivo per profili in alluminio
- Botole
- Coltelli
- Cesoie
- Frattoni inox
- Lame leviganti
- Nastri per giunti
- Pialle
- Pinze
- Seghetti
- Tasselli & viteria



SECCHI RETTANGOLARI

In polipropilene
Resistente ai solventi
Forma rettangolare
Manico in metallo
Graduato all'interno



SECCHI RETTANGOLARI

Cod. art.	6841	6842
misura	8 litri	12 litri

VASSOIO PER RULLI

In polipropilene (PP)
Resistente ai solventi



VASSOIO PER RULLI

Cod. art.	6843	6845	6846
Misure	cm.16 x 30	cm. 26 x 35	cm. 34 x 37

SECCHI IN PLASTICA

In polipropilene (PP)
Resistente ai solventi
Completo di coperchio
Certificati per uso alimentare



SECCHI IN PLASTICA TONDI

Cod. art.	2209	2210	2211	2212	2213	2214
Misure	ml.480	ml.1180	Litri 3,2	Litri 5,8	Litri 15,9	Lt 10 ovale

RETE SCOLARULLO PLASTICA

In polipropilene
Resistente ai solventi



RETE SCOLARULLO PLASTICA

Cod. art.	5779	5780	5781
Misure	cm. 12 x 18	cm. 22 x 25	cm. 26 x 28

RETE SCOLARULLO ACCIAIO

In ferro elettrosaldato

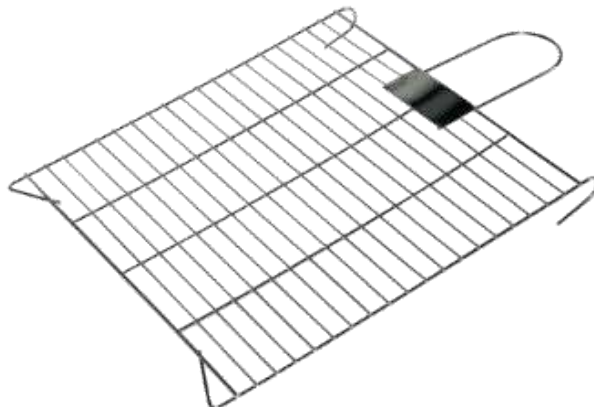

RETE SCOLARULLO ACCIAIO

Cod. art.	5785
Misura	cm. 26 x 30

TAZZA PER STUCCHI

In gomma morbida
Per la preparazione di stucchi in polvere



TAZZA PER STUCCHI

Cod. art.	4442
Misura	Ø cm 13

SUPPORTI PORTA PENNELLI

4447

4444



4445



4446



SUPPORTI PORTA PENNELLI

Cod. art.	4447	4445	4444	4446
Modello	PPL	Zincato	Alluminio	PPL



PERTICA

- ✓ Filetto italiano
- ✓ Serraggio esterno con manopole
- ✓ In alluminio



PERTICHE TELESCOPICHE ALLUMINIO

Cod. art.	misura
4403	metri 6
4404	metri 8



PERTICA

- ✓ Serraggio interno tramite avvvitamento
- ✓ In alluminio



PERTICHE TELESCOPICHE ALLUMINIO

Cod. art.	misura
4400	metri 2
4401	metri 3
4402	metri 4



PERTICA

- ✓ Serraggio interno tramite avvvitamento
- ✓ Filetto italiano
- ✓ In acciaio



PERTICHE TELESCOPICHE ACCIAIO

Cod. art.	misura
4407	mt 1,3
4405	mt 2
4406	mt 3



MANICO TELESCOPICO

- ✓ Struttura in alluminio
- ✓ Telescopico da cm. 52 a cm. 92



MANICO TELESCOPICO

Cod. art.	misura
57910	cm.18
57911	cm.25

FRUSTA A TRIPLA SPIRALE

- ✓ Indicato per miscelare materiali con medio/alta viscosità: malte, riempitivi, intonaco, colle, cemento, stucchi.
- ✓ Si adatta a tutti i trapani



FRUSTA A TRIPLA SPIRALE

Cod. art. **68118** **68119**

misura Ø mm. 120 Ø mm. 140



MISCELATORE A ELICA

- ✓ Indicato per miscelare liquidi contenenti materiali aggressivi, vernici, colle e cemento liquido
- ✓ Si adatta a tutti i trapani



MISCELATORE A ELICA

Cod. art. **6782** **6784** **6786** **6787**

misura Ø mm. 60 Ø mm. 80 Ø mm. 100 Ø mm. 120



MISCELATORE A FRUSTA

- ✓ Indicato per miscelare colle, mastici, resine dense e materiali ad alta viscosità.
- ✓ Si adatta alla maggior parte dei trapani
- ✓ Zincato



MISCELATORE A FRUSTA

Cod. art. **6790**

misura Ø mm. 120



MESCOLATORI - APRIBARATTOLO



4443



4440



4441

Cod. art. **4443** **4440** **4441**

Misure cm. 39 Plastica cm. 28 Metallo cm. 28 Metallo



4443



4440



4441

ASTA TELESCOPICA

- ✓ In alluminio per adattatore **52315**
- ✓ Misura 3 metri



52314

Cod. art.

52314

ADATTATORE

- ✓ Utilizzato per lama levigante
- ✓ Si adatta all'asta **52314**



52315

Cod. art.

52315

SPATOLA LEVIGANTE INOX



SPATOLA LEVIGANTE INOX

Cod. art. **52310** **52311** **52312**

Misure cm.65 cm.80 cm.120



ASTA TELESCOPICA

- ✓ In alluminio per adattatore **52337**
- ✓ Misura 2 metri



52338

Cod. art.

52338

ADATTATORE

- ✓ Utilizzato per lama levigante
- ✓ Si adatta all'asta **52338**



52337

Cod. art.

52337

SPATOLA LEVIGANTE INOX OCAI



SPATOLA LEVIGANTE INOX OCAI

Cod. art. **52320** **52321** **52322** **52323** **52324** **52325** **52326**

Spatola cm.15 cm.30 cm.40 cm.60 cm.80 cm.100 cm.120

Cod. art. **52330** **52331** **52332** **52333** **52334** **52335** **52336**

Lama cm.15 cm.30 cm.40 cm.60 cm.80 cm.100 cm.120



FRATTONE INOX

Per intonaco, malta, colla, gesso
Acciaio inossidabile di alta qualità, molto leggero
Misura cm. 38x12



5325

Cod. art.

5325



FRATTONE INOX AR

Lama trapezoidale angoli retti
In acciaio Inox



FRATTONE INOX AR

Cod. art.

5302

5301

5300

Misure

cm. 20 x 8 x 7

cm. 24 x 10 x 9

cm. 28 x 12 x 11



FRATTONE INOX MARMORINO

Lama trapezoidale angoli arrotondati
In acciaio Inox
MARMORINO



FRATTONE INOX MARMORINO

Cod. art.

5305

5307

5306

Misure

cm. 20 x 8

cm. 24 x 10

cm. 28 x 12



FRATTONE IN PVC

In plastica molto leggero
Per intonachino



FRATTONE IN PVC

Cod. art.

5329

Misura

cm. 28 x 13



SPATOLA DI FINITURA

Manico in gomma morbida
Lama flessibile inox
Angoli retti



SPATOLA DI FINITURA

Cod. art. 5223

Misura cm. 30



SPATOLA INOX PER STUCCO

Manico legno di faggio
Lama dritta in acciaio al carbonio temprato
Rivettata in due punti



SPATOLA INOX PER STUCCO

Cod. art. 5228 5229

Misura cm. 16 cm. 20



SPATOLA INOX PER PITTORI

Impugnatura in gomma
Lama dritta in acciaio inox



SPATOLA INOX PER PITTORI

Cod. art. 5210.20

Misura cm. 20



SPATOLA INOX OCAI

Spatola per rivestimento
Manico in gomma morbida
Lama flessibile inox
Angoli retti



SPATOLA INOX OCAI

Cod. art. 5222

Misura cm. 22



SPATOLA IN ACCIAIO CAPEC

Spatola con manico legno
Lama rigida in acciaio
Angoli retti
Misure:2/3/4/5/6/7/8/9/10/12



Cod. art.

5190

SPATOLA INOX ANGOLI RETTI

Spatola con manico in gomma morbida
Lama flessibile inox
Angoli retti
Misure: 4/6/8/10/12



Cod. art.

5210

SPATOLA INOX ANGOLI TONDI

Spatola con manico in gomma morbida
Lama flessibile inox
Angoli arrotondati
Misure:4/6/8/10/12



Cod. art.

5211

SPATOLA INOX GOLDBLATT

Spatola con impugnatura comoda
Lama in acciaio inox
Testa del martello con lega di zinco



Cod. art. 52123 52122 52120

Misure cm.7,5 cm.10 cm.15



SPATOLA DENTATA

Con manico in acciaio
Lama dentata flessibile in acciaio
Larghezza lama cm.8



4475



Cod. art.

4475

Dentatura

Fine



SPATOLA DENTATA 20

Con manico in acciaio
Lama dentata flessibile in acciaio
Larghezza lama cm.20
Trapezoidale



SPATOLA DENTATA 20

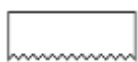

Cod. art.

4460

4461

4462

Dentatura

Fine

media

grossa



SPATOLA DENTATA 12

Con manico in acciaio
Lama flessibile in acciaio
Larghezza lama cm.12
Trapezoidale



SPATOLA DENTATA 12

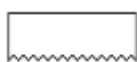

Cod. art.

4470

4471

4472

Dentatura

Fine

media

grossa

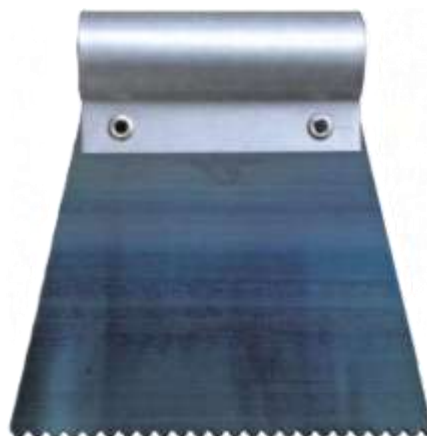

SPATOLA TRAPEZOIDALE

Con manico in acciaio
Lama liscia flessibile in acciaio
Trapezoidale



SPATOLA TRAPEZOIDALE

Cod. art.

4480

Misura

cm. 20



SPATOLE

Spatole in acciaio
Lama dentata flessibile



Cod. art. **5237** **5238** **5239**

Misure cm. 8 cm. 10 cm. 12

Spatole in acciaio
Lama liscia flessibile
Misure disponibili:
cm.2/3/4/5/6/7/8/9/10/11
12/13/14/16/18/20



Cod. art.

5235

Spatole in acciaio INOX
Lama liscia flessibile
Misure disponibili:
cm.4/6/8/10/12/14/16/20



Cod. art.

5236

Spatole in plastica per l'applicazione di stucchi
In blister da 4 pezzi
Misure: cm. 5/8/10/12



6560

Cod. art.

6560

Spatole in acciaio
In blister da 4 pezzi
Misure: cm.5/8/10/12



5230

Cod. art.

5230

Spatole in acciaio INOX
In blister da 4 pezzi
Misure disponibili: cm.5/8/10/12



5230I

Cod. art.

5230 I

In kit da 3 pezzi
Ideale per l'applicazione di strisce, stencil, e adesivi in genere
Misure: cm.6/10/12,5



5230P

Cod. art.

5230P

Per scollare e rimuovere la carta da parati
Resistenti ai solventi
In blister da 3 pezzi
Misure: cm.5/10/15



52130

Cod. art.

52130

SPATOLA PER GESSATORI

Manico in legno
Lama flessibile in acciaio
Angoli retti



SPATOLA PER GESSATORI

Cod. art.	5225	5226	5227
Misura	cm. 12	cm. 16	cm. 20

SPATOLA BILAMA

Con due lame avvitate
Manico legno di faggio
Lama in acciaio temprato



SPATOLA BILAMA

Cod. art.	5220	5221
Misura	cm. 15	cm. 20

SPATOLA MESCOLATORE

Manico in legno
Lama rigida inox
Angoli retti



SPATOLA MESCOLATORE

Cod. art.	5435	5436	5737
Misura	cm. 6	cm. 8	cm. 10

FRATTONE PER COLLE

Frattoni in acciaio dentato robusto e performante.
Per la stesura dei collanti per pavimenti
Dentatura cm.1
Misura cm. 28x12



FRATTONE PER COLLE

Cod. art.

5320

Manico in gomma morbida
 Professionale
 C20
 Adatta anche per tassello chimico



5148

Cod. art.

5148

Manico in acciaio
 Semi professionale
 C24



5149

Cod. art.

5149

Manico in acciaio
 Hobbistica
 C6



5150

Cod. art.

5150

Manico in acciaio
 Hobbistica
 C24



5165

Cod. art.

5165

Per schiuma poliuretanic
 In metallo



5145

Cod. art.

5145

FRATTAZZO

Con impugnatura in poliuretano
Base in gomma rigida



Cod. art. 5363

Misura cm. 20 x 8



FRATTAZZO IN GOMMA SPUGNA

Per la pulizia di piastrelle
Manico poliuretano
Base poliuretano
Spessore spugna cm.3



Cod. art. 5365

Misura cm.24 x 12



FRATTAZZO GOMMA SPUGNA

In gomma spugna, spessore mm. 20
Manico in legno, base alluminio



Cod. art. 5360 5362

Misura cm.24 x 10 cm.14 x 21



FRATTAZZO IN GOMMA SPUGNA

In gomma spugna blu, spessore mm. 20
Manico poliuretano, Base alluminio



Cod. art. 5366

Misura cm.14 x 21



FRATTAZZO SPUGNA

Per la pulizia di fughe
Manico poliuretano
Base poliuretano
Spessore spugna cm.4



Cod. art. 5364

Misura cm.29 x 15



SPUGNA IN LATTICE

In lattice per la pulizia di piastrelle



Cod. art.

6528

Misura

cm. 16 x 11

SPUGNA SINTETICA

In materiale sintetico per pulizie in genere



Cod. art.

6525

Misura

cm. 14 x 9

SPUGNA ANTIGRAFFIO

In materiale sintetico per pulizie in genere
Con supporto antigraffio



Cod. art.

6527

Misura

cm. 14 x 9

FRATTAZZO PER ABRASIVI

CORPO IN ABS
Impugnatura integrata
Con 2 panni abrasivi



Cod. art.

5330

Misura

cm.24 X 12

SPINGI ACQUA

Base in metallo rinforzato
Gomma sintetica



Cod. art.

5268

Misura

cm. 55

MARTELLINO IN GOMMA

Con doppia testa in gomma
Manico in legno



MARTELLINO IN GOMMA

Cod. art. **5285** **5286**

Peso gr.400 gr.550



MARTELLINO TIPO TEDESCO

Con testa in acciaio forgiato
Manico in legno
A norme DIN 1041



MARTELLINO TIPO TEDESCO

Cod. art. **5280** **5281** **5282** **5283**

Peso gr.100 gr.200 gr.300 gr.500



MAZZETTA MURATORE

Con testa in acciaio temprato
Manico in legno
A norme DIN 6475



MAZZETTA MURATORE

Cod. art. **5287** **5288**

Peso gr.1000 gr.1250

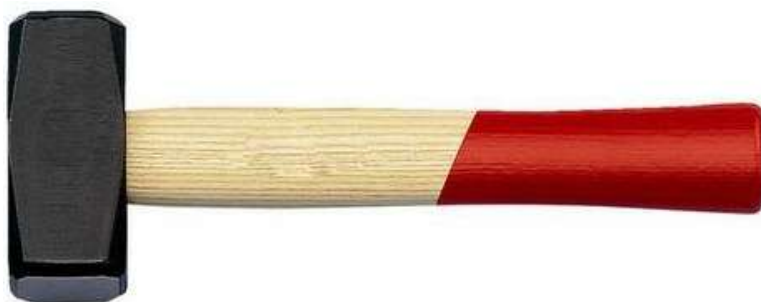

LIVELLE A 3 BOLLE

In alluminio
tre bolle: 90°- 180°- 45°
Magnetica



LIVELLE A 3 BOLLE

Cod. art. **5610** **5611** **5613**

Misure cm.30 cm.40 cm.60



Flessometro in ABS con guscio gommato
Doppio stop del nastro



FLESSOMETRO PROFESSIONALE

Cod. art.	5102	5103
misura	mt 3/19 mm	mt 5/25 mm
	5104	5105
	mt 7,5/25 mm	mt 10/25 mm



Rotella metrica in materiale plastico ABS
Manovella di riavvolgimento
Nastro in fibra di vetro



ROTELLA METRICA

Cod. art.	5600	5601
misura	metri 10	metri 20



Doppi metri in legno
A 10 aste



DOPPIO METRO IN LEGNO

Cod. art.	5605	5609
Colore	Legno	Bianco/giallo



Doppio metro in materiale sintetico
A 10 aste



DOPPIO METRO SINTETICO

Cod. art.	5608
Colore	Giallo



Metro singolo in legno



METRO SINGOLO

Cod. art.	5607
Modello	10 aste



Pinza per profili in lamiera
Spessore fino a 2 x 0,8 mm
Dimensioni 10"



Cod. art.

64154



64154

Pinza universale
Impugnatura PVC+TPR
Dimensioni 6"
Rivestito in nichel



Cod. art.

65202



65202

Pinza regolabile
Manico in plastica bicomponente
Lunghezza cm.25



Cod. art.

65250



65250

Tenaglia
Manico rivestito in PVC
Acciaio forgiato



TENAGLIA DA COSTRUZIONE

Cod. art.

65270

65275

Modello

cm.25

cm.28



Coltello con manico in gomma morbida
Per lana di roccia
Lama cm. 28



Cod. art.

4385



4385

UTENSILI

Pialla con corpo in plastica ABS
Dimensioni mm.260



PIALLA PER CARTONGESSO GRANDE

Cod. art.	6896	6897
Modello	Pialla	Lama



Pialla con corpo in plastica ABS
Dimensioni mm.140



PIALLA PER CARTONGESSO MEDIA

Cod. art.	68981	68982
Modello	Pialla	Lama



Pialla con corpo in materiale sintetico antiurto
Lama mm.60 x 40
In blister



PIALLA PER CARTONGESSO PICCOLA

Cod. art.	68983
Modello	Pialla



Seghetto universale
Manico in gomma morbida
Dentatura temprata e punta affilata
Lunghezza cm.20

Cod. art.	
	4387



Cesoia con impugnatura in PVC-TPR
Lunghezza cm.25

Cod. art.	
	64150



GANCIO CON MOLLA SERIE PLUS

Sospensione dei profili da soffitto 27/50 mm
Corpo acciaio zincato
Spessore molla 0,7 mm
Larghezza molla 15 mm



GANCIO CON MOLLA SERIE PLUS

Bordi	schacciato	arrotondato
Cod. art.	43300	43301

GANCIO ORTOGONALE SERIE PLUS

Per il bloccaggio a incrocio dei profili da soffitto
Profilo 27/50 mm
Corpo acciaio zincato
Spessore 0,6 mm



GANCIO ORTOGONALE SERIE PLUS

Bordi	schacciato	arrotondato
Cod. art.	43303	43302

GIUNTO LINEARE

Per profilo da soffitto 27/50 mm
In acciaio zincato
Spessore 0,5 mm



43309

Cod. art.	43309
------------------	-------

STAFFA UNIVERSALE

Per profili a parete
Per la correzione del fuori piombo
Per montanti larghi 60 mm



STAFFA UNIVERSALE

Distanza	3 – 12 mm	3 – 25 mm
Cod. art.	43304	43315

CAVALIERE DOPPIA ORDINATURA

Per la giunzione del profilo da soffitto 27/45
Spessore 1 mm
Con foro da \varnothing 6 mm



CAVALIERE DOPPIA ORDINATURA

Bordi	schacciato	arrotondato
Cod. art.	43308	43307

AGGANCIATO A SCATTO

per profili da 45 mm
Per contro pareti in aderenza o distanziate
Spessore 0,8 mm
Con foro da \varnothing 6 mm



AGGANCIATO A SCATTO

Bordi	schacciato	arrotondato
Cod. art.	43306	43305

PENDINO - PIEGA «E»

Per sospensione.
In acciaio zincato \varnothing 4 mm



PENDINO PIEGA E

Cod. art.	43320	43321	43323	43325
Misure	cm.25	cm.50	cm.100	cm.200

PENDINO - PIEGA «C»

Per sospensione.
In acciaio zincato \varnothing 4 mm



PENDINO PIEGA C

Cod. art.	43310	43311	43313
Misure	cm.25	cm.50	cm.100

ANCORINA A FARFALLA PLUS™

In acciaio con vite e rondella
Per murature vuote a parete e soffitto
Lunghezza totale 82 mm
Diametro Ø 12/M4



Cod. art.



43292

ANCORINA A FARFALLA MOON™

In acciaio con occhiolo chiuso, dado e rondella
Per murature vuote a soffitto
Lunghezza totale 94 mm
Diametro Ø 12/M4



Cod. art.



43290

ANCORINA A FARFALLA PLUS™

In acciaio con vite e rondella
Per murature vuote a parete e soffitto
Lunghezza totale 93 mm
Diametro Ø 14/M4,5



Cod. art.



43293

ANCORINA A FARFALLA MOON™

In acciaio con occhiolo chiuso, dado e rondella
Per murature vuote a soffitto
Lunghezza totale 93 mm
Diametro Ø 14/M4,5



Cod. art.



43291

TASSELLO RAPIDO A PERCUSSIONE

In nylon Bordo largo bombato con vite a chiodo
Impronta a croce pozidriv
Dimensioni mm. 6 x 38 giallo



Cod. art.



43255

TASSELLO PROLUNGATO CON VITE

Misura Ø 9 x 60
Scatola da 100 pezzi



Cod. art.



43296

TASSELLO NYLON CON VITE

Tassello nylon con vite
Misura Ø 9 x 45
Scatola da 100 pezzi



Cod. art.



43295

TASSELLO NYLON OCCHIOLO CHIUSO

Tassello nylon occhiolo chiuso
Misura Ø 9 x 45
Scatola da 100 pezzi



Cod. art.



43297

TASSELLO MULTIUSO

In nylon F4 mm.8 + vite 5 x 45
Barattolo con 150 pezzi



43251

Cod. art.

43251

TASSELLO MULTIUSO

in nylon F4 mm.6 + vite 4,5 x 40
Barattolo con 100 pezzi



43252

Cod. art.

43252

VITE AUTOFILETTANTE

✓ per cartongesso in acciaio temperato



VITE AUTOFILETTANTE NERA

Cod. art.	43270	43271	43272
Pz. 1000	3,5 x 25	3,5 x 35	3,5 x 45

VITE AUTOFILETTANTE

✓ per cartongesso in acciaio temperato



Cod. art.	43275	43276	43277
Pz. 50	3,5 x 25	3,5 x 35	3,5 x 45

VITE AUTOPERFORANTE

Per cartongesso in acciaio temperato

In scatola



VITE AUTOPERFORANTE NERA

Cod. art.	43280
Pz.200	3,5 x 25

VITE AUTOPERFORANTE

Per lamiera zincata

Testa mezza tonda ranellata

Acciaio temperato

In scatola



VITE AUTOPERFORANTE ZINCATA

Cod. art.	43260	43261
misura	4,2 x 13 Pz.1000	4,2 x 13 Pz.50

**BOTOLA D'ISPEZIONE CON TELAIO IN ALLUMINIO E SPORTELLO IN CARTONGESSO
SPESSORE INSTALLABILE 13 MM - FER-BOARD™**

Profilo Shark™: alluminio

Tipologia della lastra: Cartongesso Idro

Tipologia di chiusura: con Clic-clac



BOTOLA DI ISPEZIONE

Cod. art.	43330	43331	43332	43333	43334
misura	20 x 20	30 x 30	40 x 40	50 x 50	60 x 60



NASTRO DI RINFORZO IN CARTA MICROFORATO

Per giunti e angoli



NASTRO DI RINFORZO IN CARTA MICROFORATO

Cod. art.	6469.50	6469.51
Misura	mm. 50 x 75 metri	mm. 50 x 23 metri

NASTRO IN TNT

Realizzato in fibre di vetro compresse.
Per unire pannelli in cartongesso e coprire crepe e graffi sottili su pareti e soffitti



NASTRO IN TNT

Cod. art.	6469.54
Formato	mm. 50 x 25 metri

NASTRO SALDA FESSURE COPRICREPE

Adesivo di facile utilizzo
Viene applicato sulle crepe dei muri
Dopo l'applicazione si può tinteggiare o tappezzare



NASTRO SALDA FESSURE

Cod. art.	6469.8
Formato	mm 50 x 10 mt.

NASTRO IN TNT MICROFORATO

Estremamente resistente per la protezione di giunti tra pannelli in cartongesso



NASTRO IN TNT MICROFORATO

Cod. art.	6469.52	6469.53
Formato	mm. 48 x 25 metri	mm. 96 x 25 metri

NASTRO A RETE PER CARTONGESSO

Coprigiunto autoadesivo in fibra di vetro.
Perfetto per il rinforzo dei giunti.



NASTRO A RETE PER CARTONGESSO

Cod. art.	6469.6	6469.7
Formato	mm. 50 x 20 metri	mm. 50 x 90 metri

NASTRO BIADESIVO PER CARTONGESSO

Con pellicola singola
Spessore 3 mm
Densità: 32 kg/m³



NASTRO BIADESIVO PER CARTONGESSO

Cod. art.	64592	64593
misura	mm.50x20mt	mm.70 x 20 mt

TRACCIATORE A PIOMBO

Dimensioni filo 30 mt
 Polvere 50 gr.
 Struttura in PP+PE



Cod. art. **5293**

Modello SET



POLVERE PER TRACCIATORE

La polvere per traccia righe è un prodotto professionale non tossico
 Disponibile in due colori



Cod. art. **5294** **5295**

Misure Blu gr.224 Rosso gr.224



MATITE DA CARPENTIERE

- ✓ In legno di tiglio laccata rossa
- ✓ Per legno e pietra



Cod. art. **5615** **5616**

Misure cm. 18 cm. 25



TAZZE A FILTRO

Il **Filtro per vernici a tazza** con rete filtrante in nylon:
Fine: 80 micron – 5000 maglie
Media: 125 micron – 2500 maglie
Medio-larga: 190 micron – 1000 maglie



Cod. art. **6552** **6551** **6550**

Maglie 2.000 5.000 10.000



nettuno Paint Marker - punta fine

Pennarello per ritocchi a colori brillante che non sbiadiscono e resistenti all'acqua
Marker coprente, permanente anche su vetro.



NETTUNO PAINT MARKER PUNTA FINE

Cod. art.

3000

Bianco

Argento

Oro

Nero



nettuno Paint Marker - punta media

Pennarello per ritocchi a colori brillante che non sbiadiscono e resistenti all'acqua
Marker coprente, permanente anche su vetro.



NETTUNO PAINT MARKER PUNTA MEDIA

Cod. art.

3001

Bianco

Rosso

Blu

Giallo

Nero

Azzurro



Grigio



Marrone



Verde chiaro



Verde scuro



Oro



Argento

Cod. art.

3002

Espositore pezzi 96



3002



nettuno Paint Marker - punta grossa

Pennarello per ritocchi a colori brillante che non sbiadiscono e resistenti all'acqua
Marker coprente, permanente anche su vetro.



NETTUNO PAINT MARKER PUNTA GROSSA

Cod. art.

3003

Bianco

Rosso

Blu

Giallo

nero



CARATTERISTICHE E BENEFICI

L'inchiostro industriale è resistente alle sbavature e all'acqua per segni più duraturi. Il robusto fusto in plastica resiste agli usi industriali più impegnativi e rappresenta l'alternativa economica ai fusti in metallo ad alto costo. Il cappuccio a clip integrato. L'inchiostro privo di xilene elimina i problemi di salute.

USI DI SUPERFICIE

Ferro
Alluminio
Pvc
Plastica
Vetro
Cartone
Legname
Panno e tessuti

Cod. art.

22420



22420



Marcatori DURA-INK chisel 55

DURA-INK® 55



MARCATORI DURA INK CHISEL 55

Cod. art.	Cod. art.	Cod. art.
22411	22412	22413
Nero	Blu	Rosso



Marcatori DURA-INK bullet tip 60

DURA-INK® 60



MARCATORI DURA INK BULLET TIP 60

Cod. art.	Cod. art.	Cod. art.
22421	22422	22423
Nero	Blu	Rosso



Marcatori DURA-INK fine 15

DURA-INK®15



MARCATORI DURA INK FINE 15

Cod. art.	Cod. art.	Cod. art.
22431	22432	22433
Nero	Blu	Rosso





Rulli Pennelli & Decoro

- Plafoniere antigoccia
- Plafoncini
- Pennellesse
- Ovalini
- Spalter
- Standarini
- Astuccini
- Rulli per esterno
- Rulli per interno
- Rullo per stucchi
- Mini rulli
- Attrezzi per decori
- Impugnature
- Stencil



CAPEC
WORK PROJECT

RULLO NYLON PRO

- ✓ Rullo in poliammide
- ✓ Per superfici cementizie
- ✓ Uso interno/esterno
- ✓ Pelo da mm.20
- ✓ **Diametro Ø 55**

UTILIZZO: vernici acriliche, isolanti, pitture al quarzo, primer, pigmentati, Silicati, silossanici



Cod. art.	5700	5701
misura	cm.20	cm. 23

CAPEC
WORK PROJECT



RULLO TRILOBATO

- ✓ Rullo in poliammide
- ✓ Per superfici cementizie
- ✓ Uso interno/esterno
- ✓ Pelo da mm.23
- ✓ **Diametro Ø 55**

UTILIZZO: vernici acriliche, isolanti, pitture al quarzo, primer, pigmentati, Silicati, silossanici



Cod. art.	5711
misura	cm.20

CAPEC
WORK PROJECT



RULLO CORDONATO

- ✓ Completo di impugnatura
- ✓ Ideale per idropitture, guaine, catrame
- ✓ Pelo da mm.20
- ✓ **Diametro Ø 20**

UTILIZZO: Colle, fissativi, isolanti, pitture al quarzo, pitture minerali, primer pigmentati, silicati, vernici a base olio



Cod. art.	5730	5731
misura	cm.20	cm. 25



RULLO NYLON 47

- ✓ Rullo in poliammide
- ✓ Ideale per emulsioni liquide
- ✓ Pelo da mm.12
- ✓ **Diametro mm.47**

UTILIZZO: Idropitture, pitture minerali, primer pigmentati, primer trasparenti, resine trasparenti

SUPERFICI: Gesso e cartongesso, intonaco a malta, muri interni.



RULLO NYLON 47

Cod. art.	5727	5728
misura	cm.20	cm. 23



CAPEC
WORK PROJECT

RULLO NYLON 55

- ✓ Rullo in poliammide
- ✓ Ideale per emulsioni liquide
- ✓ Pelo da mm.12
- ✓ **Diametro mm.55**

UTILIZZO: Idropitture, pitture minerali, primer pigmentati, primer trasparenti, resine trasparenti

SUPERFICI: Gesso e cartongesso, intonaco a malta, muri interni.



RULLO NYLON 55

Cod. art.	5747	5748
misura	cm.20	cm. 23



CAPEC
WORK PROJECT

RULLO MICROMIX

- ✓ Rullo in microfibra
- ✓ Ideale per finiture uniformi con prodotti a media densità, opache e satinare
- ✓ **Pelo da mm.9**
- ✓ **Diametro mm.47**

UTILIZZO: Idropitture, primer pigmentati, primer trasparenti, smalti opachi

SUPERFICI: Gesso e cartongesso, intonaco a tempera, civile stucco, muri interni



RULLO MICROMIX

Cod. art.	5734	5735
misura	cm.20	cm. 23



CAPEC
WORK PROJECT

RULLO MICROFIBRA 9

- ✓ Rullo in microfibra
- ✓ Ideale per finiture uniformi a strati sottili
- ✓ Fondi lisci
- ✓ Pelo da mm.9
- ✓ **Diametro mm.47**

UTILIZZO: Idropitture, pitture minerali, primer pigmentati, primer trasparenti, resine trasparenti

SUPERFICI: Gesso e cartongesso, intonaco a tempera, laminati metallici, legno, muri interni



RULLO MICROFIBRA 9

Cod. art.	5725	5726
-----------	------	------

misura	cm.20	cm. 23
--------	-------	--------

CAPEC
WORK PROJECT



RULLO MICROFIFRA 5

- ✓ Rullo in microfibra
- ✓ Ideale per finiture uniformi a strati sottili
- ✓ Fondi lisci
- ✓ Pelo da mm.5
- ✓ **Diametro mm.47**

UTILIZZO: Idropitture, pitture minerali, primer pigmentati, primer trasparenti, resine trasparenti

SUPERFICI: Gesso e cartongesso, intonaco a tempera, laminati metallici, legno, muri interni



RULLO MICROFIFRA 5

Cod. art.	5717	5718
-----------	------	------

misura	cm.20	cm. 23
--------	-------	--------

CAPEC
WORK PROJECT



RULLO MOHAIR

- ✓ Completo di impugnatura
- ✓ Diametro rullo mm.42
- ✓ Altezza pelo mm.5
- ✓ Per superfici lisce
- ✓ Uso: lacche, smalti sintetici, Impregnanti, vernici antivegetative



RULLO MOHAIR

Cod. art.	5740	5741	5742
-----------	------	------	------

misura	cm.10	cm. 15	cm. 18
--------	-------	--------	--------



RULLO MICROFIBRA 47

- ✓ Rullo in microfibra
- ✓ Ad alto potere di assorbimento
- ✓ Per finiture senza gocce e pelucchi
- ✓ Pelo da mm.14
- ✓ **Diametro mm.47**

UTILIZZO: Idropitture, impregnanti, lacche sintetiche, latex, primer e smalti

SUPERFICI: Gesso e cartongesso, intonaco a tempera civile, muri interni, soffitti, stucco



RULLO MICROFIBRA 47

Cod. art.	5723	5724
-----------	------	------

misura	cm.20	cm. 23
--------	-------	--------



CAPEC
WORK PROJECT

RULLO MICROFIBRA 55

- ✓ Rullo in microfibra
- ✓ Ad alto potere di assorbimento
- ✓ Per finiture senza gocce e pelucchi
- ✓ Pelo da mm.14
- ✓ **Diametro mm.55**

UTILIZZO: Idropitture, impregnanti, lacche sintetiche, latex, primer e smalti

SUPERFICI: Gesso e cartongesso, intonaco a tempera civile, muri interni, soffitti, stucco



RULLO MICROFIBRA 55

Cod. art.	5745	5746
-----------	------	------

misura	cm.20	cm. 23
--------	-------	--------



CAPEC
WORK PROJECT

RULLO PUTTY ROLLER PER STUCCO

- ✓ Rullo in nylon
- ✓ Pelo da mm.18
- ✓ **Diametro Ø 48**

UTILIZZO: Adatto per intonaci pronti all'uso con consistenza piuttosto fluida

SUPERFICI: Gesso e cartongesso, intonaco a malta, stucco, muri interni



RULLO PUTTY ROLLER

Cod. art.	52316	52317
-----------	-------	-------

misura	cm.18	cm. 25
--------	-------	--------



IMPUGNATURE

- ✓ Manico rullo a innesto
- ✓ Impugnatura in plastica
- ✓ Tondino in ferro Ø 8



Cod. art.	5792	5793
misura	cm.20	cm. 23

- ✓ La maniglia ergonomica e robusta si adatta a rulli larghi cm 20 e 23



Cod. art.	57921	57922
misura	cm.18	cm. 25

RULLO KIT HOBBY

- ✓ Rullo in poliester
- ✓ Con rete scola rullo
- ✓ Pelo da mm.20



Cod. art.	5770	5771
misura	cm.20	cm. 25



SET PITTURA 55

Composizione Kit:

- ✓ Rullo grande con impugnatura cm.20
- ✓ Mini rullo con impugnatura cm.10
- ✓ Pennello
- ✓ Vaschetta cm.26x33



Cod. art.	68471
-----------	-------



RULLO SERBATOIO

- ✓ Rullo con serbatoio integrato
- ✓ Compatibile con ogni superficie
- ✓ Ampia copertura
- ✓ Lavabile e riutilizzabile



Cod. art.	5722
-----------	------



MINI RULLO VELOUR

- ✓ Ideale per finiture a strati sottili
- ✓ Fondi lisci

Cod. art.	6821	6820
misura	cm.5	cm. 10



MINI RULLO POLIACRILICO

- ✓ Ideale per finiture idropitture, primer pigmentati, resine

Cod. art.	5776	5775	5774
misura	cm.5	cm. 10	cm.15



RULLOTTO POLIACRILICO

- ✓ Ideale per finiture idropitture, primer pigmentati, resine
- ✓ **Diametro mm.30**

Cod. art.	5773	5772
misura	cm.10	cm. 15



MINI RULLO POLIACRILICO

- ✓ Ideale per finiture a strati sottili, completo di impugnatura
- ✓ Pelo mm.12

Cod. art.	68473
misura	cm.10



MINI RULLO MICROFIBRA

- ✓ Rullino termo a pelo basso in microfibra
- ✓ Per finiture uniformi lucide

Cod. art.	5777	5778
misura	cm.5	cm. 10



RULLO ANGOLARE

- ✓ Per la verniciatura di angoli, completo di impugnatura
- ✓ Pelo mm.9 - **Diametro mm.100**

Cod. art.
5720



MINI RULLO FLOCCATO

- ✓ Mini rullo in velluto
- ✓ Finitura fine per Smalto all'acqua

Cod. art. **6823** **6824**

misura cm.5 cm. 10



MINI RULLO MOLTOPRENE

- ✓ Mini rullo in velluto
- ✓ Finitura fine per Smalto all'acqua

Cod. art. **6817**

misura cm.10



MINI RULLO SPUGNA

- ✓ Mini rullo in velluto
- ✓ Finitura fine per Smalto all'acqua

Cod. art. **6816** **6815**

misura cm.5 cm. 10



KIT RULLO PER STRISCE

- ✓ Per la verniciatura di tagli e strisce sulle pareti
- ✓ Pelo mm.12 - **Diametro mm.35**

Cod. art.

68190



SET PITTURA 72

Composizione Kit:

- ✓ 1 vassoio 1 pennello 2 mini rulli 1 impugnatura

Cod. art.

68470



IMPUGNATURE PER MINI RULLI



Cod. art. **5795** **5794** **57931**

Misura cm.5 cm. 10 cm.15

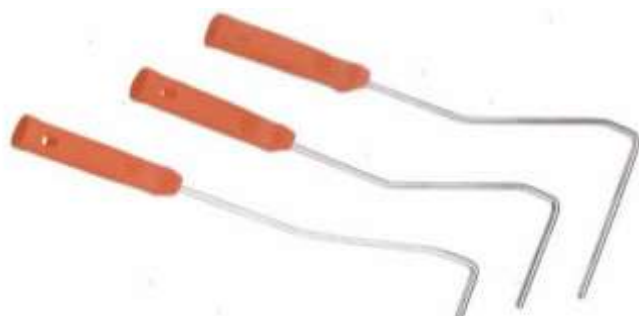

PLAFONIERA S250

- ✓ Plafoniera professionale in setola pura
- ✓ Manico in legno con grip antiscivolo
- ✓ Indicato per idropitture, lavabili e quarzi
- ✓ Su superfici interne ed esterne



PLAFONIERA S250

Cod. art.	misura	Setole
2948	120x30	83
2949	140x40	83
2950	150x50	83
2951	160x65	95



PLAFONCINO S914

- ✓ Plafoncino in setola pura
- ✓ Manico in legno
- ✓ Ghiera ramata



PLAFONCINO S914

Cod. art.	misura	Setole
2907	70x30	70
2910	100x30	70
2912	120x30	70
2914	140x40	76
2915	150x50	76



PLAFONCINO S400

- ✓ Plafoncino in setola mista
- ✓ Manico in plastica
- ✓ Ghiera nichel



PLAFONCINO S400

Cod. art.	misura	Setole
2907 E	70x30	60
2910 E	100x30	60
2912 E	120x30	60
2914 E	140x40	65
2915 E	150x50	70



PENNELLESSA S100

- ✓ Pennellessa
- ✓ Misto setola
- ✓ Manico plastica



PENNELLESSA S100



Cod. art.	2520	2530	2540	2550	2560	2570
Misure	20	30	40	50	60	70

PENNELLESSA S120

- ✓ Pennellessa
- ✓ Pura setola
- ✓ Manico in legno verniciato



PENNELLESSA S120



Cod. art.	2620	2630	2640	2650	2660	2670
Misura	20	30	40	50	60	70

PENNELLESSA MATRIX

- ✓ Pennellessa
- ✓ Setole sintetiche
- ✓ Manico in gomma



PENNELLESSA MATRIX



Cod. art.	2430	2440	2450	2460
Misura	30	40	50	60

PENNELLESSA 90 FLAT BRUSH

- ✓ Pennellessa
- ✓ Manico in plastica
- ✓ Ghiera nichel
- ✓ Setole sintetiche



PENNELLESSA 90 FLAT BRUSH



Cod. art.	24200	24201	24202	24203	24204
Misura	25	35	50	70	80

PENNELLESA BOX 31 FLAT BRUSH

- ✓ Manico legno
- ✓ Ghiera in acciaio - Setole sintetiche
- ✓ Box da 180 pezzi



Cod. art. Misure in assortimento

2510 mm 25/35/50/60/75



PENNELLESA 31 FLAT BRUSH

- ✓ Manico legno
- ✓ Ghiera in acciaio - Setole sintetiche



Cod. art. 24910 24911 24912 24913 24914 24915

Misura 25 35 50 60 75 100



OVALINO S333

- ✓ Manico legno
- ✓ Ghiera nichel
- ✓ Pura setola



Cod. art. 2802 2804 2806 2808 2810 2812 2814 2816 2818 2820

Misura 2 4 6 8 10 12 14 16 18 20



RADIATORE S160

- ✓ Manico legno
- ✓ Ghiera ramata
- ✓ Pura setola



Cod. art. 2720 2730 2740 2750 2760 2770

Misura 20 30 40 50 60 70



PENNELLO SINTETICO PUNTA TONDA

CATEGORIA BELLE ARTI



7411.00	7411.02	7411.04	7411.06	7411.08	7411.10	7411.12	7411.14	7411.16	7411.18	7411.20
Tondo n° 0	Tondo n° 2	Tondo n° 4	Tondo n° 6	Tondo n° 8	Tondo n° 10	Tondo n° 12	Tondo n° 14	Tondo n° 16	Tondo n° 18	Tondo n° 20

PENNELLO SINTETICO PUNTA PIATTA



7412.00	7412.02	7412.04	7412.06	7412.08	7412.10	7412.12	7412.14	7412.16	7412.18	7412.20
Piatto n° 0	Piatto n° 2	Piatto n° 4	Piatto n° 6	Piatto n° 8	Piatto n° 10	Piatto n° 12	Piatto n° 14	Piatto n° 16	Piatto n° 18	Piatto n° 20

ASTUCCINO ETERNA 579



7604	7606	7608	7610	7612
Piatto n° 4	Piatto n° 6	Piatto n° 8	Piatto n° 10	Piatto n° 12

ASTUCCINO ETERNA 582



7504	7506	7508	7510	7512
Tondo n° 4	Tondo n° 6	Tondo n° 8	Tondo n° 10	Tondo n° 12

ASTUCCINO ETERNA 577



7400.00	7400.02	7400.04	7400.06	7400.08	7400.10	7400.12	7412.14	7412.16
Piatto n° 0	Piatto n° 2	Piatto n° 4	Piatto n° 6	Piatto n° 8	Piatto n° 10	Piatto n° 12	Piatto n° 14	Piatto n° 16

ASTUCCINO ETERNA 766



7410.00	7410.02	7410.04	7410.06	7410.08	7410.10	7410.12	7410.14	7410.16
Tondo n° 0	Tondo n° 2	Tondo n° 4	Tondo n° 6	Tondo n° 8	Tondo n° 10	Tondo n° 12	Tondo n° 14	Tondo n° 16

PENNELLI ACQUARELLI



Cod. art.

Box

7850

144 pezzi

Cod. art.

Cartella

7860

24 pezzi

PENNELLI STANDARINI

- ✓ In setola bionda
- ✓ Manico legno



Cod. art.

7871

7872

7873

Misura

N°1

N°2

N°3

PENNELLO SPALTER

- ✓ Per decorazioni terre fiorentine
- ✓ In setola bionda
- ✓ Ghiera nichel



Cod. art.

4232

4233

4234

Misura

70

100

120

RULLO IN SPUGNA PER DECORI

- ✓ Rullo completo di impugnatura
- ✓ Per smalti a basso contenuto di solventi e vernici acriliche.
- ✓ Rullo cm. 20



Cod. art.

5750

5751

5752

Modello

Fine

Media

Grana

- ✓ Spugna sintetica
- ✓ Misura media tonda



6518

Cod. art.

6518



- ✓ Spugna sintetica
- ✓ Misura media rettangolare



6519

Cod. art.

6519



- ✓ Spugna sintetica
- ✓ Misura media mezzaluna



6523

Cod. art.

6523



- ✓ Spugna Naturale del mediterraneo



SPUGNA DI MARE NATURALE

Cod. art.

6520

6521

Misure

Media

Grande



- ✓ Guanto in materiale poliesteri



6515

Cod. art.

6515



- ✓ Tampone effetto prato



TAMPONE EFFETTO PRATO

Cod. art.

5789

57891

Misure

15 x 15

10 x 20



- ✓ Tampone In gomma di caotchou
- ✓ Per creare effetto finto legno
- ✓ Misura cm.15



5790

Cod. art.

5790



- ✓ Spatola per terre fiorentine
- ✓ Doppia lama per calibrare la pressione
- ✓ In plastica antiurto



4231

Cod. art.

4231



ATTREZZI PER DECORI

- ✓ Frattone in plastica
- ✓ Angoli smussati flessibile
- ✓ Misura cm. 24 x 9



Cod. art. 
5332

- ✓ Frattone in plastica
- ✓ Lati ondulati flessibile
- ✓ Misura cm. 24 x 9



Cod. art. 
5331

- ✓ Rullo per decori
- ✓ Completo di impugnatura
- ✓ Rullo cm.20
- ✓ Effetto tamponato
- ✓ ES300



Cod. art. 
5799.08

- ✓ Rullo per decori
- ✓ Completo di impugnatura
- ✓ Rullo cm.20
- ✓ Effetto corteccia
- ✓ ES600



Cod. art. 
5799.05

- ✓ Rullo per decori
- ✓ Completo di impugnatura
- ✓ Rullo cm.20
- ✓ Effetto onda
- ✓ ES200



Cod. art. 
5799.07

- ✓ Rullo per decori
- ✓ Completo di impugnatura
- ✓ Rullo cm.200
- ✓ Effetto marmorizzato
- ✓ ES700



Cod. art. 
5799.06

- ✓ Pelli sintetiche
- ✓ cm.26 x 26 set 3 pelli



Cod. art. 
5799.09

- ✓ Tamponi per decori



Cod. art.	5786	5787	5788
Misure	Ø mm.50	cm.15x15	cm.20x20

Rulli Pennelli & Decoro

Collezione Stencil 3D

Codice **3295** Misura cm. 35 x 40



COLLEZIONE STENCIL 3D

P802

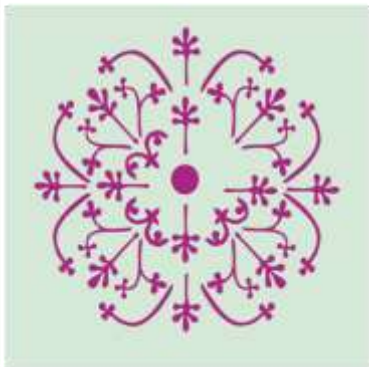

P813



P815



P817

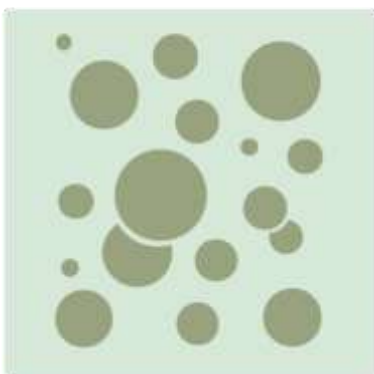

P819



P823



P816



P801



P613



Codice **3295** Misura cm. 60 x 90

Collezione Stencil



COLLEZIONE STENCIL 21X14

Codice **3295** Misura cm. 21 x 29

Basta alle decorazioni piatte, arricchisci i tuoi progetti con un meraviglioso effetto tridimensionale, grazie alla pasta 3D che può essere colorata come preferisci. Perfetto anche per creare una base materica, arricchendo con particolari a rilievo ogni superficie.

416



403



404

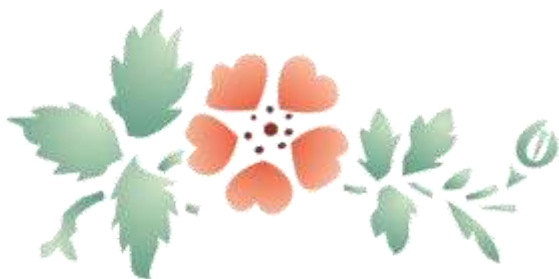

408



442



407



460



441



435



432



Rulli Pennelli & Decoro

Collezione Stencil

Codice **3295** Misura cm. 21 x 90



COLLEZIONE STENCIL 21X90



011 – altezza disegno H cm. 18,5



027 – altezza disegno H cm. 13,5



023– altezza disegno H cm. 8



007– altezza disegno H cm. 16



025 – altezza disegno H cm.8



028 – altezza disegno H cm. 14



215 – altezza disegno H cm. 13



216 – altezza disegno H cm. 9,7



054 - H cm. 8



002 - H cm. 15,4



009 - cm. 12,5



001 - H cm. 17,5



029 - cm. 9,3



036 - H cm. 7,6



057 - cm. 4,5



223 - cm. 6,3



031 - H cm. 9



034 - H cm. 9



NOËL & MARQUET
DESIGN ELEMENTS



NOËL & MARQUET è l'espressione di una profonda e duratura passione per la decorazione d'interni. Radicata nell'esperienza di un'azienda familiare con oltre 50 anni di artigianato, il marchio NOËL & MARQUET è diventato un riferimento globale per modanature architettoniche e soluzioni murali di alta gamma.



WALLSTYL®

SOFISTYL®

NOMASTYL®



Modello MISURE E CODICE

E25



Lunghezza (L) 2 m
Altezza (H) 80 mm
Larghezza (W) 50 mm
Unità d'imballaggio 60 ml/ct
CODICE 58714



Modello MISURE E CODICE

E26



Lunghezza (L) 2 m
Altezza (H) 65 mm
Larghezza (W) 40 mm
Unità d'imballaggio 72 ml/ct
CODICE 58715



Modello MISURE E CODICE

E27



Lunghezza (L) 2 m
Altezza (H) 90 mm
Larghezza (W) 80 mm
Unità d'imballaggio 32 ml/ct
CODICE 58716



Modello MISURE E CODICE

E12



Lunghezza (L) 2 m
Altezza (H) 30 mm
Larghezza (W) 30 mm
Unità d'imballaggio 230 ml/ct
CODICE 58711



Modello MISURE E CODICE

E21



Lunghezza (L) 2 m
Altezza (H) 30 mm
Larghezza (W) 10 mm
Unità d'imballaggio 120 ml/ct
CODICE 58712



Modello MISURE E CODICE

E23



Lunghezza (L) 2 m
Altezza (H) 55 mm
Larghezza (W) 55 mm
Unità d'imballaggio 86 ml/ct
CODICE 58713

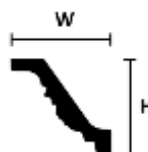

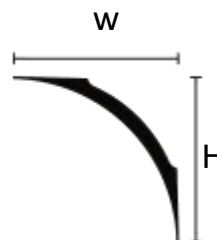

NE1 – COD. 58753

Lunghezza (L) 2 m
Altezza (H) 40 mm
Larghezza (W) 40 mm



58753

NE2 – COD. 58754

Lunghezza (L) 2 m
Altezza (H) 60 mm
Larghezza (W) 60 mm



58754

NE3 – COD. 58755

Lunghezza (L) 2 m
Altezza (H) 82 mm
Larghezza (W) 82 mm



58755

NE4 – COD. 58756

Lunghezza (L) 2 m
Altezza (H) 100 mm
Larghezza (W) 100 mm



58756



B2 – COD. 58726

Lunghezza (L) 2 m
Altezza (H) 35 mm
Larghezza (W) 35 mm



58726

B5 – COD. 58727

Lunghezza (L) 2 m
Altezza (H) 50 mm
Larghezza (W) 50 mm



58727

B1 – COD. 58725

Lunghezza (L) 2 m
Altezza (H) 66 mm
Larghezza (W) 78 mm



58725

B8 – COD. 58728

Lunghezza (L) 2 m
Altezza (H) 82 mm
Larghezza (W) 82 mm



58728

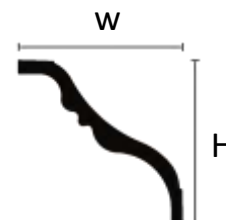

TL – COD. 58752

Lunghezza (L) 2 m
Altezza (H) 150 mm
Larghezza (W) 150 mm



58752

TI – COD. 58751

Lunghezza (L) 2 m
Altezza (H) 138 mm
Larghezza (W) 138 mm



58751

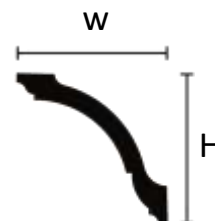

GO – COD. 58733

Lunghezza (L) 2 m
Altezza (H) 80 mm
Larghezza (W) 80 mm



58733

GP – COD. 58734

Lunghezza (L) 2 m
Altezza (H) 100 mm
Larghezza (W) 100 mm



58734

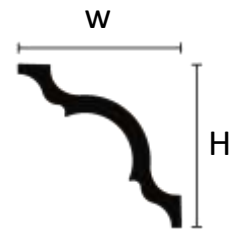

A3 – COD. 58723

Lunghezza (L) 2 m
Altezza (H) 30 mm
Larghezza (W) 30 mm



58723

A2 – COD. 58722

Lunghezza (L) 2 m
Altezza (H) 50 mm
Larghezza (W) 50 mm



58722

A1 – COD. 58721

Lunghezza (L) 2 m
Altezza (H) 80 mm
Larghezza (W) 80 mm



58721

A – COD. 58720

Lunghezza (L) 2 m
Altezza (H) 110 mm
Larghezza (W) 110 mm



58720



K – COD. 58740

Lunghezza (L) 2 m
Altezza (H) 70 mm
Larghezza (W) 70 mm



58740

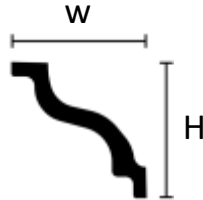

SL – COD. 58746

Lunghezza (L) 2 m
Altezza (H) 100 mm
Larghezza (W) 100 mm



58746

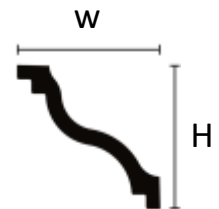

GR – COD. 58735

Lunghezza (L) 2 m
Altezza (H) 85 mm
Larghezza (W) 80 mm



58735



SM – COD. 58747

Lunghezza (L) 2 m
Altezza (H) 105 mm
Larghezza (W) 95 mm



58747

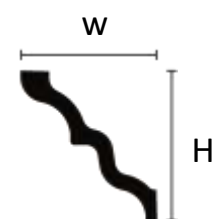

AT – COD. 58724

Lunghezza (L) 2 m
Altezza (H) 100 mm
Larghezza (W) 95 mm



58724

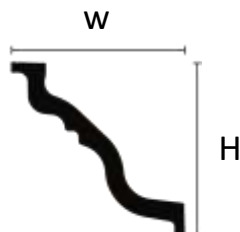

E – COD. 58731

Lunghezza (L) 2 m
Altezza (H) 25 mm
Larghezza (W) 17 mm



58731

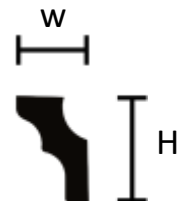



H – COD. 58737

Lunghezza (L) 2 m
Altezza (H) 45 mm
Larghezza (W) 50 mm

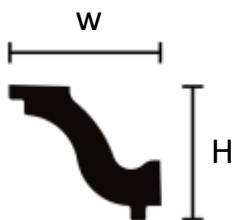

GK – COD. 58757

Lunghezza (L) 2 m
Altezza (H) 75 mm
Larghezza (W) 50 mm

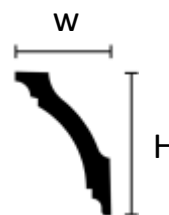

J – COD. 58739

Lunghezza (L) 2 m
Altezza (H) 45 mm
Larghezza (W) 50 mm

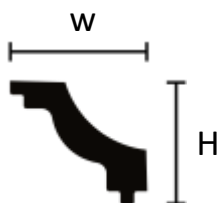

I – COD. 58738

Lunghezza (L) 2 m
Altezza (H) 38 mm
Larghezza (W) 16 mm



QR – COD. 58745

Lunghezza (L) 2 m
Altezza (H) 21 mm
Larghezza (W) 21 mm

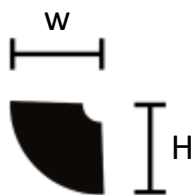

N – COD. 58743

Lunghezza (L) 2 m
Altezza (H) 70 mm
Larghezza (W) 20 mm



O – COD. 58744

Lunghezza (L) 2 m
Altezza (H) 40 mm
Larghezza (W) 20 mm





ST2 – COD. 58748

Lunghezza (L) 2 m
Altezza (H) 50 mm
Larghezza (W) 50 mm



ST3 – COD. 58749

Lunghezza (L) 2 m
Altezza (H) 75 mm
Larghezza (W) 75 mm

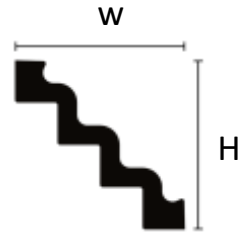

M2 – COD. 58742

Lunghezza (L) 2 m
Altezza (H) 59 mm
Larghezza (W) 18 mm



M1 – COD. 58741

Lunghezza (L) 2 m
Altezza (H) 120 mm
Larghezza (W) 30 mm



F – COD. 58732

Lunghezza (L) 2 m
Altezza (H) 33 mm
Larghezza (W) 33 mm



D – COD. 58730

Lunghezza (L) 2 m
Altezza (H) 49 mm
Larghezza (W) 42 mm



C – COD. 58729

Lunghezza (L) 2 m
Altezza (H) 83 mm
Larghezza (W) 66 mm

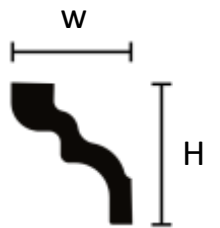

GT – COD. 58736

Lunghezza (L) 2 m
Altezza (H) 117 mm
Larghezza (W) 50 mm

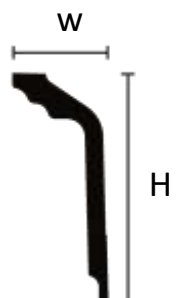



Modello

MISURE E CODICE

IL3

Lunghezza (L) 2 m
Altezza (H) 50 mm
Larghezza (W) 33 mm
(G) mm 21 – (F) mm 15
CODICE 58810

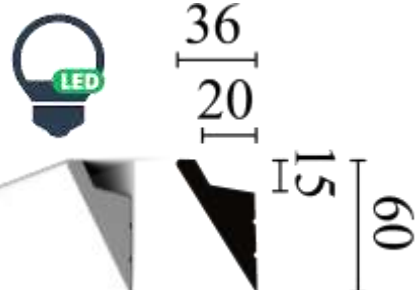

Modello

MISURE E CODICE

IL4

Lunghezza (L) 2 m
Altezza (H) 60 mm
Larghezza (W) 36 mm
(G) mm 20 – (F) mm 15
CODICE 58811

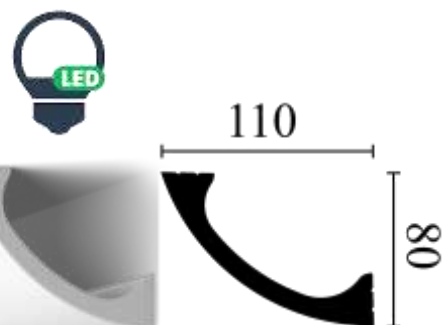

Modello

MISURE E CODICE

WT3

Lunghezza (L) 2 m
Altezza (H) 80 mm
Larghezza (W) 110 mm
CODICE 58797



Modello

MISURE E CODICE

IL12

Lunghezza (L) 2 m
Altezza (H) 20 mm
Larghezza (W) 25 mm
CODICE 58812





WL7 – COD. 58799

Lunghezza (L) 2 m
Altezza (H) 25 mm
Larghezza (W) 13 mm



58799

WL1 – COD. 58793

Lunghezza (L) 2 m
Altezza (H) 38 mm
Larghezza (W) 18 mm



58793



WL2 – COD. 58794

Lunghezza (L) 2 m
Altezza (H) 40 mm
Larghezza (W) 20 mm



58794

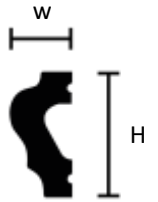

WL3 – COD. 58786

Lunghezza (L) 2 m
Altezza (H) 38 mm
Larghezza (W) 16 mm



58786



SP1 – COD. 58798

Lunghezza (L) 2 m
Altezza (H) 28 mm
Larghezza (W) 9 mm



58798



WL11 – COD. 58813

Lunghezza (L) 2 m
Altezza (H) 49 mm
Larghezza (W) 15 mm



58813



WL12 – COD. 58814

Lunghezza (L) 2 m
Altezza (H) 24,5 mm
Larghezza (W) 11 mm



58814



WL6 – COD. 58795

Lunghezza (L) 2 m
Altezza (H) 75 mm
Larghezza (W) 22 mm



58795



WD2 – COD. 58796

Lunghezza (L) 2 m
Altezza (H) 70 mm
Larghezza (W) 15 mm



58796





FL1 – COD. 58790

Lunghezza (L) 2 m
Altezza (H) 80 mm
Larghezza (W) 13 mm



58790

FL2 – COD. 58791

Lunghezza (L) 2 m
Altezza (H) 120 mm
Larghezza (W) 15 mm



58791



FB2 – COD. 58792

Lunghezza (L) 2 m
Altezza (H) 100 mm
Larghezza (W) 13 mm



58792



CF3 – COD. 58788

Lunghezza (L) 2 m
Altezza (H) 120 mm
Larghezza (W) 22 mm
(G) mm 15 – (F) mm 83



58788



CF1 – COD. 58789

Lunghezza (L) 2 m
Altezza (H) 110mm
Larghezza (W) 22 mm
(G) mm 14 – (F) mm 88



58789



D1 – COD. 58804

Lunghezza (L) 2 m
Altezza (H) 80 mm
Spessore (W) 15 mm



58804



M38 – COD. 58800

Lunghezza (L) 2 m
Altezza (H) 38 mm
Spessore (W) 13 mm



58800



M58 – COD. 58801

Lunghezza (L) 2 m
Altezza (H) 58 mm
Spessore (W) 13 mm



58801



M80 – COD. 58802

Lunghezza (L) 2 m
Altezza (H) 80 mm
Spessore (W) 15 mm



58802



MODELLO B27



MISURE E CODICE

Diametro (Ø) 66,5 cm
CODICE 58774



MODELLO B33



MISURE E CODICE

Diametro (Ø) 46,5 cm
CODICE 58775



MODELLO B25



MISURE E CODICE

Diametro (Ø) 42 cm
CODICE 58773



MODELLO B23



MISURE E CODICE

Diametro (Ø) 42 cm
CODICE 58770



MODELLO B16



MISURE E CODICE

Diametro (Ø) 39 cm
CODICE 58782



MODELLO B20



MISURE E CODICE

Diametro (Ø) 44 cm
CODICE 58785



MODELLO B12



MISURE E CODICE

Diametro (Ø) 30 cm
CODICE 58780



MODELLO B22



MISURE E CODICE

Altezza (D) 30 mm
 Larghezza (W) 30 mm
CODICE 58777



MODELLO B18



MISURE E CODICE

Diametro (Ø) 28 cm
CODICE 58783



MODELLO B9



MISURE E CODICE

Diametro (Ø) 15,5 cm
CODICE 58778



MODELLO BC



MISURE E CODICE

Diametro (Ø) 12 cm
CODICE 58662





T102

Altezza (D) 50 mm
Larghezza (W) 50 mm
CODICE 58640

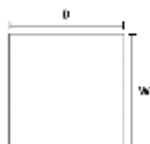

T101

Altezza (D) 50 mm
Larghezza (W) 50 mm
CODICE 58641

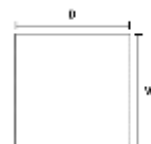

T133

Altezza (D) 50 mm
Larghezza (W) 50 mm
CODICE 58642

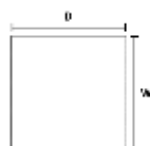

T141

Altezza (D) 50 mm
Larghezza (W) 50 mm
CODICE 58643

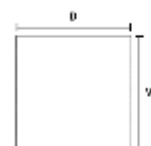

NOMA® BEAMS VIGA DECORATIVAS

La trave decorativa in legno di noce imitazione NOMABEAM, in poliuretano, riproduce l'aspetto pulito e preciso delle travi in legno, ma con maggiore facilità di montaggio.

Oltre ad essere molto leggera e resistente, le travi sono cave, permettendo di nascondere cavi e tubi all'interno.

- ✓ Poliuretano
- ✓ Alta densità
- ✓ Resistente
- ✓ Finto legno

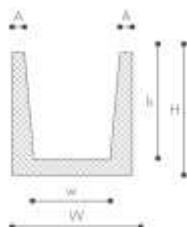

Lunghezza (L) 3 mt
Altezza (H) 100 mm
Larghezza (W) 100 mm
h cm. 8
w cm. 6
A cm. 1,5



STILE E CODICE PRODOTTO
Decorazione da soffitto
CODICE 58803

thermoplan®

- Isolamento termico
- Isolamento acustico
- Conducibilità termica bassa
- Polistirene estruso



58646	58647	58649
Altezza 80 mm Larghezza 125 mm SPESSORE mm.3 Imballo 40 lastre	Altezza 80 mm Larghezza 125 mm SPESSORE mm.6 Imballo 20 lastre	Altezza 60 mm Larghezza 80 mm SPESSORE mm.9 Imballo 20 lastre

noma®nature

Il rotolo isolante in sughero Noma Nature protegge le tue stanze dal freddo e dal rumore. Puoi facilmente applicare questo isolamento in sughero con colla di sughero, sia su pavimenti che su pareti. Il sughero è riciclabile al 100%. Con un rullo si copre una superficie di 2,5 m².



58644	58645
Altezza 50 cm Lunghezza 10 metri SPESSORE mm.2	Altezza 50 cm Lunghezza 10 metri SPESSORE mm.4

noma®reflex

PANNELLO TERMORIFLETTENTE

Il film isolante è realizzato in polistirene e film polimerico termo riflettente. Isola la parete dietro il riscaldatore in modo che fino al 95% della radiazione di calore venga riflessa nella stanza.

Il tappetino isolante può essere fissato all'isolamento dietro il radiatore con uno speciale adesivo per polistirolo. Ciò riduce la perdita di calore fino al 20%.

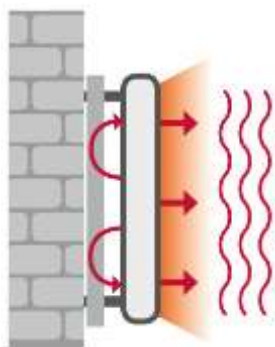

3997
Altezza 50 mm Lunghezza 5 metri SPESSORE mm.4

noma®acoustic

Sono utilizzati per l'assorbimento acustico in studio, home cinema, sala audizioni, sala riunioni, ecc. La forma profilata e la struttura flessibile del materiale garantiscono un assorbimento acustico ottimale, riducendo il riverbero, il montaggio è facile con l'aiuto di un adesivo acustico.

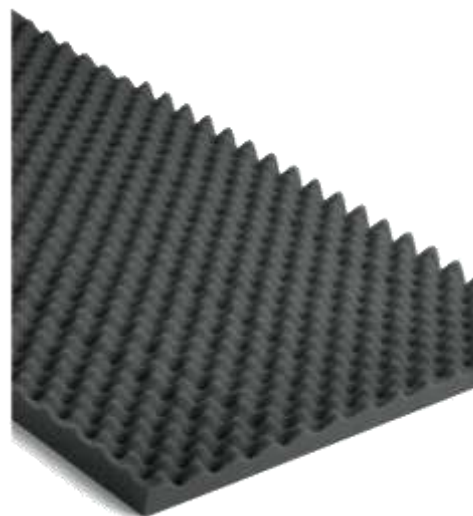

58651
Altezza 50 mm Lunghezza 1 metri SPESSORE cm.2,5

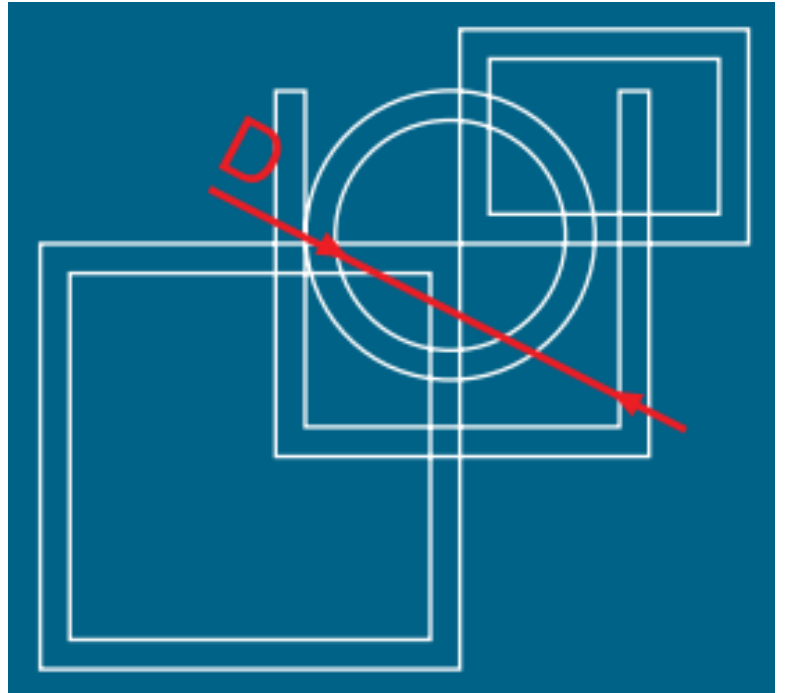

Profili Decorativi

- Battiscopa
- Salvaparete
- Coprispigolo
- Sgusce igieniche
- Giunti per pavimenti
- Profili in alluminio



COPRISPIGOLO ASSORBIMENTO URTI IN PVC



COPRISPIGOLO ASSORBIMENTO URTI MT2

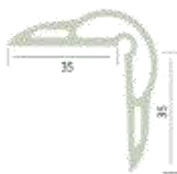

Materiale idoneo per ambienti ove si lavorano alimenti, strutture ospedaliere, socio assistenziali e sanitarie in genere

Il nostro materiale plastico è totalmente impermeabile, liscio, lavabile e disinfettabile.

Non rilascia sostanze chimiche nelle normali condizioni d'uso e non viene intaccato dall'utilizzo di detergenti e sgrassanti tradizionali.



Lunghezza (L) 2m Spessore (T) 3mm (W) 35 mm (W) 35 mm BIANCO CODICE 80500	Lunghezza (L) 2m Spessore (T) 3mm (W) 35 mm (W) 35 mm BLU CODICE 80501	Lunghezza (L) 2m Spessore (T) 3mm (W) 35 mm (W) 35 mm GIALLO CODICE 80502	Lunghezza (L) 2m Spessore (T) 3mm (W) 35 mm (W) 35 mm GRIGIO CODICE 80503	Lunghezza (L) 2m Spessore (T) 3mm (W) 35 mm (W) 35 mm TRASPARENTE CODICE 80507
---	--	---	---	--

SALVAPARETE IN PVC

I salvaparete sono particolarmente adatti per uso domestico, uffici, sale d'attesa e tutti i locali dove i muri sono particolarmente esposti a possibili danneggiamenti. La versione nel colore trasparente è adatta ad ogni tipo di arredamento.



Bianco



SALVAPARETE IN PVC



Trasparente

Lunghezza (L) 80 cm Spessore (T) 4 mm (W) 80 mm BIANCO CODICE Z1 BI	Lunghezza (L) 80 cm Spessore (T) 4 mm (W) 80 mm TRASPARENTE CODICE Z1 TR
--	---



MODELLO
1BS

COPRISPIGOLO Z2

Materiale idoneo per ambienti ove si lavorano alimenti, strutture ospedaliere, socio assistenziali e sanitarie in genere.

Il nostro materiale plastico è totalmente impermeabile, liscio, lavabile e disinfettabile.

Non rilascia sostanze chimiche nelle normali condizioni d'uso e non viene intaccato dall'utilizzo di detersivi e sgrassanti tradizionali.

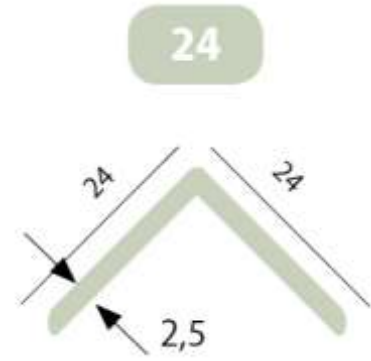

COPRISPIGOLO IN PVC Z2

Lunghezza 3 mt Spessore 2,5 mm (W) 24 mm (W) 24 mm NERO CODICE Z2 NE	Lunghezza 3 mt Spessore 2,5 mm (W) 24 mm (W) 24 mm NOCE CODICE Z2 NO	Lunghezza 3 mt Spessore 2,5 mm (W) 24 mm (W) 24 mm BIANCO CODICE Z2 BI	Lunghezza 3 mt Spessore 2,5 mm (W) 24 mm (W) 24 mm IROKO CODICE Z2 IR	Lunghezza 3 mt Spessore 2,5 mm (W) 24 mm (W) 24 mm CILIEGIO CODICE Z2 CI	Lunghezza 3 mt Spessore 2,5 mm (W) 24 mm (W) 24 mm FRASSINO CODICE Z2 FR
--	--	--	---	--	--

COPRISPIGOLO Z8



Lunghezza 3 mt
Spessore 3,5 mm
(W) 30 mm
(W) 30 mm
BIANCO
CODICE Z8 BI



COPRISPIGOLO IN PVC Z8

SPECIAL TI-AL
ANODIZZATO ORO
BRILLANTE

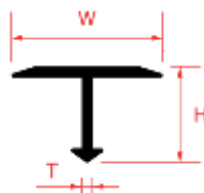

MISURE E CODICE PRODOTTO
Lunghezza (L) 90 cm
Spessore (T) 1 mm
Larghezza (W) 14 mm
Altezza (H) 9 mm

CODICE 79032



79032

SPECIAL TI-AL
ANODIZZATO ARGENTO
BRILLANTE

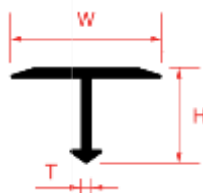

MISURE E CODICE PRODOTTO
Lunghezza (L) 90 cm
Spessore (T) 1 mm
Larghezza (W) 14 mm
Altezza (H) 9 mm

CODICE 79033



79033

SPECIAL SEMI FLAT-AC
SATINATO

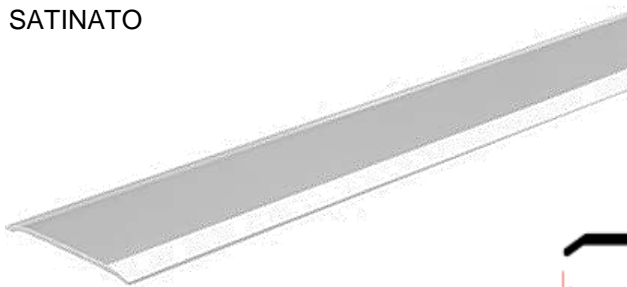

In Blister

MISURE E CODICE PRODOTTO
Lunghezza (L) 90 cm
Spessore (T) 1 mm
Larghezza (W) 25 mm
Con adesivo

CODICE 79038



79038

SPECIAL SEMI FLAT-AC
ACCIAIO LUCIDO



In Blister

MISURE E CODICE PRODOTTO
Lunghezza (L) 90 cm
Spessore (T) 0,7 mm
Larghezza (W) 25 mm
Con adesivo

CODICE 79045



79045

SPECIAL SEMIFLAT-AL
ACCIAIO LUCIDO

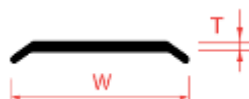

In Blister

MISURE E CODICE PRODOTTO
Lunghezza (L) 90 cm
Spessore (T) 0,7 mm
Larghezza (W) 40 mm
Con adesivo

CODICE 79046



79046

SPECIAL SEMI-AL
ANODIZZATO ORO



In Blister

MISURE E CODICE PRODOTTO

Lunghezza (L) 90 cm
Spessore (T) 1 mm
Larghezza (W) 25 mm
Con adesivo

CODICE 79041



SPECIAL SEMI-AL
ANODIZZATO ARGENTO

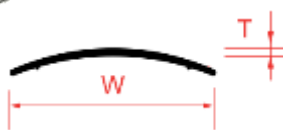

In Blister

MISURE E CODICE PRODOTTO

Lunghezza (L) 90 cm
Spessore (T) 1 mm
Larghezza (W) 30 mm
Con adesivo

CODICE 79049



SPECIAL SEMI-AL
ANODIZZATO ORO
BRILLANTE

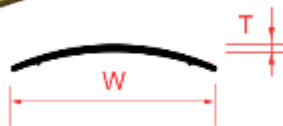

In Blister

MISURE E CODICE PRODOTTO

Lunghezza (L) 90 cm
Spessore (T) 1 mm
Larghezza (W) 30 mm
Con adesivo

CODICE 79050



SPECIAL TERMTILT-AL
ANODIZZATO ORO



In Blister

MISURE E CODICE PRODOTTO

Lunghezza (L) 90 cm
Spessore (T) 1 mm
Altezza (H) 10 mm
Larghezza (W) 30 mm
Con adesivo

CODICE 79056



SPECIAL TERMTILT-AL
ANODIZZATO ARGENTO



In Blister

MISURE E CODICE PRODOTTO

Lunghezza (L) 90 cm
Spessore (T) 1 mm
Altezza (H) 10 mm
Larghezza (W) 30 mm
Con adesivo

CODICE 79060



Materiale idoneo per ambienti ove si lavorano alimenti, strutture ospedaliere, socio assistenziali e sanitarie in genere.

Il nostro materiale plastico è totalmente impermeabile, liscio, lavabile e disinfettabile. Non rilascia sostanze chimiche nelle normali condizioni d'uso e non viene intaccato dall'utilizzo di detersivi e sgrassanti tradizionali.



Raccordo in PVC rigido 20x20 mm
Confezione: 100 metri | Barre da 2,5 metri

MODELLO: RI 9

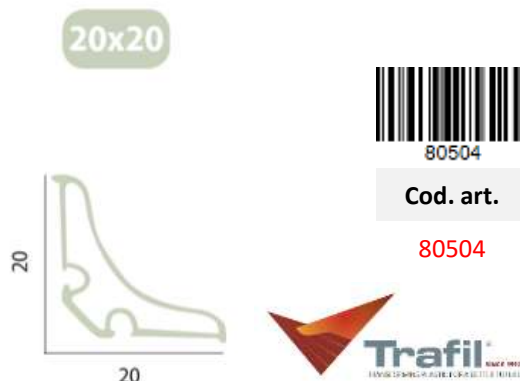

Materiale idoneo per ambienti ove si lavorano alimenti, strutture ospedaliere, socio assistenziali e sanitarie in genere

Il nostro materiale plastico è totalmente impermeabile, liscio, lavabile e disinfettabile. Non rilascia sostanze chimiche nelle normali condizioni d'uso e non viene intaccato dall'utilizzo di detersivi e sgrassanti tradizionali.



Sguscia in PVC flessibile 20x20 mm
Confezione: 100 metri | Barre da 2 metri

MODELLO: M10

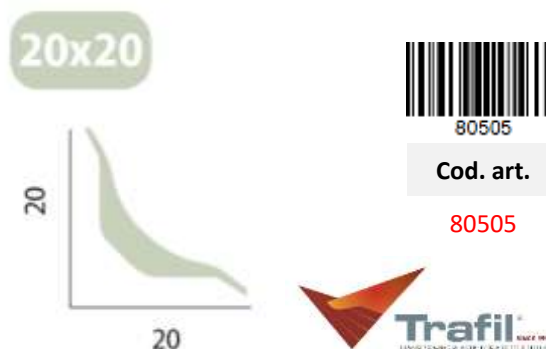

Materiale idoneo per ambienti ove si lavorano alimenti, strutture ospedaliere, socio assistenziali e sanitarie in genere

Il nostro materiale plastico è totalmente impermeabile, liscio, lavabile e disinfettabile. Non rilascia sostanze chimiche nelle normali condizioni d'uso e non viene intaccato dall'utilizzo di detersivi e sgrassanti tradizionali.



Sguscia in PVC flessibile 32 x 32 mm
Confezione: 80 metri | Barre da 2 metri

MODELLO: M8



BATTISCOPIA IN PVC



BATTISCOPIA IN PVC



BIANCO
CODICE Z7 BI



NOCE
CODICE Z7 NO



NERO
CODICE Z7 NE



GRIGIO
CODICE Z7 GC



NOCE
EFFETTO LEGNO
CODICE N3 N



NOCE CHIARO
EFFETTO LEGNO
CODICE N3 NC



ARGENTO
EFFETTO METALLO
CODICE N3 AO

Materiale idoneo per ambienti ove si lavorano alimenti, strutture ospedaliere, socio assistenziali e sanitarie in genere.

Lunghezza (L) 2mt
Spessore (T) 2mm
Altezza (70) mm
Larghezza (7) mm

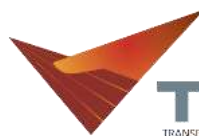
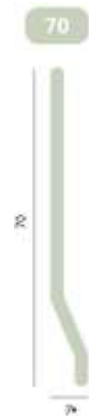

Trafil
SINCE 1992
TRANSFORMING PLASTIC FOR A BETTER FUTURE

Profili Decorativi per il Fai da te



PROFILO ANGOLARE IN ALLUMINIO

ANGOLARE
EQUAL SIDED ANGLE
ALLUMINIO - SATINATO

Lunghezza (L) 2 mt Spessore (T) 2 mm (W) 10 mm (W) 10 mm CODICE 8006	Lunghezza (L) 2 mt Spessore (T) 2 mm (W) 15 mm (W) 15 mm CODICE 8007	Lunghezza (L) 2 mt Spessore (T) 2 mm (W) 20 mm (W) 20 mm CODICE 8008	Lunghezza (L) 2 mt Spessore (T) 2 mm (W) 25 mm (W) 25 mm CODICE 8009	Lunghezza (L) 2 mt Spessore (T) 2 mm (W) 30 mm (W) 30 mm CODICE 8010	Lunghezza (L) 2 mt Spessore (T) 2 mm (W) 40 mm (W) 40 mm CODICE 8011
---	---	---	---	---	---



PROFILO ANGOLARE L IN ALLUMINIO

"L"
UN - EQUAL SIDED ANGLE
ALLUMINIO - SATINATO

Lunghezza (L) 2 mt Spessore (T) 1 mm (W) 15 mm (H) 10 mm CODICE 8012	Lunghezza (L) 2 mt Spessore (T) 1 mm (W) 20 mm (H) 10 mm CODICE 8013	Lunghezza (L) 2 mt Spessore (T) 1 mm (W) 30 mm (H) 15 mm CODICE 8014	Lunghezza (L) 2 mt Spessore (T) 1 mm (W) 40 mm (H) 15 mm CODICE 8015
---	---	---	---



PROFILO PIATTO IN ALLUMINIO

PIATTO
FLAT BAR
ALLUMINIO - SATINATO

Lunghezza (L) 2 mt Spessore (T) 2 mm (W) 12 mm CODICE 8001	Lunghezza (L) 2 mt Spessore (T) 2 mm (W) 15 mm CODICE 8002	Lunghezza (L) 2 mt Spessore (T) 2 mm (W) 20 mm CODICE 8003	Lunghezza (L) 2 mt Spessore (T) 2 mm (W) 25 mm CODICE 8004	Lunghezza (L) 2 mt Spessore (T) 2 mm (W) 30 mm CODICE 8005
--	--	--	--	--

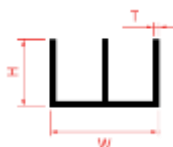

PROFILO DOPPIA U IN ALLUMINIO

DOPPIA "U"
UU - PROFILE
ALLUMINIO - SATINATO

Lunghezza (L) 2 mt Spessore (T) 2 mm (W) 16 mm (H) 12 mm CODICE 8019	Lunghezza (L) 2 mt Spessore (T) 2 mm (W) 20 mm (H) 18 mm CODICE 8020
---	---

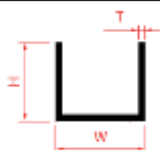

PROFILO U IN ALLUMINIO

"U"
U - PROFILE
ALLUMINIO - SATINATO

Lunghezza (L) 2 mt Spessore (T) 2 mm (W) 8 mm (H) 8 mm CODICE 8016	Lunghezza (L) 2 mt Spessore (T) 2 mm (W) 10 mm (H) 10 mm CODICE 8017	Lunghezza (L) 2 mt Spessore (T) 2 mm (W) 10 mm (H) 15 mm CODICE 8018
---	---	---

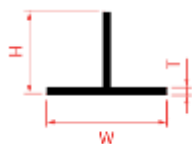

PROFILO T IN ALLUMINIO

"T"
T PROFILE
ALLUMINIO - SATINATO

Lunghezza (L) 2 mt Spessore (T) 1,5 mm (W) 15 mm (H) 15 mm CODICE 8039	Lunghezza (L) 2 mt Spessore (T) 1,5 mm (W) 20 mm (H) 20 mm CODICE 8040	Lunghezza (L) 2 mt Spessore (T) 1,5 mm (W) 30 mm (H) 15 mm CODICE 8041
---	---	---



TONDO VUOTO
ALLUMINIO - SATINATO



Lunghezza (L) 2 mt Spessore (T) 1 mm (D) 6 mm CODICE 8024	Lunghezza (L) 2 mt Spessore (T) 1 mm (D) 8 mm CODICE 8025	Lunghezza (L) 2 mt Spessore (T) 1 mm (D) 10 mm CODICE 8026	Lunghezza (L) 2 mt Spessore (T) 1 mm (D) 12 mm CODICE 8027	Lunghezza (L) 2 mt Spessore (T) 1 mm (D) 16 mm CODICE 8028	Lunghezza (L) 2 mt Spessore (T) 1 mm (D) 20 mm CODICE 8029
---	---	--	--	--	--

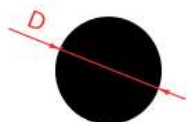

TONDO PIENO
ALLUMINIO - SATINATO



Lunghezza (L) 2 mt Spessore (T) 1 mm (D) 6 mm CODICE 8030	Lunghezza (L) 2 mt Spessore (T) 1 mm (D) 8 mm CODICE 8031	Lunghezza (L) 2 mt Spessore (T) 1 mm (D) 10 mm CODICE 8032
---	---	--

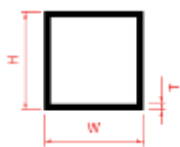

TUBO QUADRO
ALLUMINIO - SATINATO



Lunghezza (L) 2 mt Spessore (T) 1 mm (W) 10 mm (H) 10 mm CODICE 8033	Lunghezza (L) 2 mt Spessore (T) 1 mm (W) 15 mm (H) 15 mm CODICE 8034	Lunghezza (L) 2 mt Spessore (T) 1 mm (W) 20 mm (H) 20 mm CODICE 8035
---	---	---

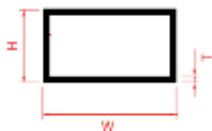

TUBO RETTANGOLARE
ALLUMINIO - SATINATO



Lunghezza (L) 2 mt Spessore (T) 1 mm (W) 20 mm (H) 10 mm CODICE 8037	Lunghezza (L) 2 mt Spessore (T) 1 mm (W) 30 mm (H) 15 mm CODICE 8038
---	---

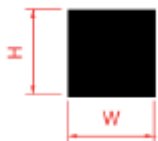

QUADRO PIENO
ALLUMINIO - SATINATO



Lunghezza (L) 2 mt Spessore (T) 1 mm (W) 10 mm (H) 10 mm CODICE 8036



UNGHIETTA
J-PROFILE
ALLUMINIO - SATINATO



Lunghezza (L) 2 mt Spessore (T) 1 mm (W) 18 mm (H) 7 mm CODICE 8021	Lunghezza (L) 2 mt Spessore (T) 1 mm (W) 22 mm (H) 7 mm CODICE 8022	Lunghezza (L) 2 mt Spessore (T) 1 mm (W) 25 mm (H) 7 mm CODICE 8023
--	--	--

Profili Decorativi per il Fai da te

ANGOLARE

ALLUMINIO - ARGENTO LUCIDO



Lunghezza (L) 2 mt Spessore (T) 2 mm (W) 10 mm (W) 10 mm CODICE 79004	Lunghezza (L) 2 mt Spessore (T) 2 mm (W) 15 mm (W) 15 mm CODICE 79005	Lunghezza (L) 2 mt Spessore (T) 2 mm (W) 20 mm (W) 20 mm CODICE 79006	Lunghezza (L) 2 mt Spessore (T) 2 mm (W) 25 mm (W) 25 mm CODICE 79007	Lunghezza (L) 2 mt Spessore (T) 2 mm (W) 30 mm (W) 30 mm CODICE 79008
--	--	--	--	--



"L"

ALLUMINIO - ARGENTO LUCIDO

Lunghezza (L) 2 mt Spessore (T) 1 mm (W) 15 mm (H) 10 mm CODICE 79009	Lunghezza (L) 2 mt Spessore (T) 1 mm (W) 20 mm (H) 10 mm CODICE 79010	Lunghezza (L) 2 mt Spessore (T) 1 mm (W) 25 mm (H) 15 mm CODICE 79012	Lunghezza (L) 2 mt Spessore (T) 1 mm (W) 30 mm (H) 15 mm CODICE 79011	 <small>PROFILO ANGOLARE ARGENTO LUCIDO</small>
--	--	--	--	--



PIATTO

ALLUMINIO - ARGENTO LUCIDO

Lunghezza (L) 2 mt Spessore (T) 2 mm (W) 15 mm CODICE 79000	Lunghezza (L) 2 mt Spessore (T) 2 mm (W) 20 mm CODICE 79001	Lunghezza (L) 2 mt Spessore (T) 2 mm (W) 25 mm CODICE 79002	Lunghezza (L) 2 mt Spessore (T) 2 mm (W) 30 mm CODICE 79003	 <small>PROFILO PIATTO ARGENTO LUCIDO</small>
---	---	---	---	--

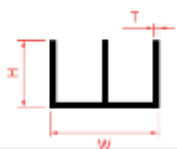

DOPPIA "U"

ALLUMINIO - ARGENTO LUCIDO

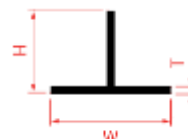

"T"

ALLUMINIO - ARGENTO LUCIDO

Lunghezza (L) 2 mt Spessore (T) 1 mm (W) 20 mm (H) 18 mm CODICE 79015	Lunghezza (L) 2 mt Spessore (T) 1,5 mm (W) 15 mm (H) 15 mm CODICE 79020
--	--

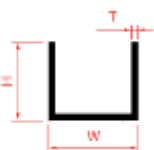

"U"

ALLUMINIO - ARGENTO LUCIDO



UNGHETTA

ALLUMINIO - ARGENTO LUCIDO

Lunghezza (L) 2 mt Spessore (T) 2 mm (W) 10 mm (H) 10 mm CODICE 79013	Lunghezza (L) 2 mt Spessore (T) 2 mm (W) 10 mm (H) 15 mm CODICE 79014	Lunghezza (L) 2 mt Spessore (T) 1 mm (W) 18 mm (H) 7 mm CODICE 79016
--	--	---



TONDO VUOTO

ALLUMINIO - ARGENTO LUCIDO

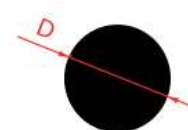

TONDO PIENO

ALLUMINIO - ARGENTO LUCIDO

Lunghezza (L) 2 mt Spessore (T) 1 mm Diametro (D) 12 mm CODICE 79017	Lunghezza (L) 2 mt Spessore (T) 1 mm Diametro (D) 16 mm CODICE 79018	Lunghezza (L) 2 mt Spessore (T) 1 mm Diametro (D) 8 mm CODICE 79019
--	--	---



Abrasivi & taglio

- Smerigliatrici
- Tamponi
- Velcro ricambio
- Carta telata
- Carta al silicio
- Carta Flessibile soft
- Spugnette
- Panni
- Dischi da taglio
- Spazzole
- Scrostatori



- ✓ Smerigliatrice in plastica con impugnatura
- ✓ Base d'appoggio carta abrasiva in gomma
- ✓ Dimensioni: cm.23 x 10,5



65781

Cod. art.

65781



6578

Cod. art.

6578



- ✓ Smerigliatrice in plastica con impugnatura
- ✓ Base d'appoggio carta abrasiva in gomma
- ✓ Dimensioni: cm.21 x 10



6566

Cod. art.

6566



- ✓ Tampone in gomma morbida
- ✓ Base d'appoggio carta abrasiva in gomma
- ✓ Dimensioni: Ø cm.12,5



6577

Cod. art.

6577



- ✓ Smerigliatrice in plastica
- ✓ Con attacco per asta telescopica
- ✓ Dimensioni: cm.21 x 10,5



65782

Cod. art.

65782



- ✓ Tampone in gomma morbida
- ✓ Dimensioni: cm.12 x 7



6565

Cod. art.

6565



- ✓ Velcro adesivo
- ✓ Ideale per la sostituzione della base velcrata di platorelli e levigatrici
- ✓ Dimensioni: H. cm.32 x 1 metro



10900

Cod. art.

10900



CARTA ABRASIVA NC 11

- ✓ Impermeabile al carburo di silicio
- ✓ Per levigature manuali ed a umido di stucchi e vernici
- ✓ Per legno, marmo, pietra, granito
- ✓ Grane disponibili: 40-60-80-100-120-150-180-220-240-280-320-400



Cod. art.

Cod. art.

6387 - 100 mt

6388 - 5 mt



CARTA VELCRATA CREF

- ✓ Su velcro per aderire su utensili e levigatrici predisposte.
- ✓ Buona flessibilità per lavorazioni con utensile orbitale
- ✓ Per legni grezzi duri e resinosi
- ✓ Rotoli da 25 metri
- ✓ Grane disponibili: 60-80-100-120-150-180-220

Cod. art.



6360

CARTA VELCRATA CREF



TELA ABRASIVA TL J

- ✓ Rotolo in tela abrasiva flessibile
- ✓ Per levigatura a mano o con orbitali
- ✓ Per metallo, legno grezzo o verniciato
- ✓ Rotoli da 25 metri
- ✓ Grane disponibili: 60-80-100-120-150-180-220

Cod. art.



6365

TELA ABRASIVA TL J



DISCHI LAMELLARI

- ✓ In ossido di alluminio
- ✓ Adatti per metallo, legno e plastica
- ✓ Diametro mm115
- ✓ Grane: 40-60-80-100-120

ALTA QUALITÀ

LAMELLE
76

TIPO 27

FORTE



Cod. art.



6410

DISCHI LAMELLARI

CARTA ABRASIVA CIL

- ✓ Impermeabile con supporto in lattice
- ✓ Al carburo di silicio
- ✓ Per levigatura manuale e ad umido
- ✓ Per stucchi, vernici nel settore della carrozzeria
- ✓ In fogli da cm. 23 x 28
- ✓ Grane disponibili: 60/80/100/120/150/180/220/240
280/320/360/400/500/600/800/1000/1200/2000



Cod. art.



6300

CARTA ABRASIVA CIL

CARTA ABRASIVA SOFT SPUGNA

- ✓ Flessibile accoppiata a spugna
- ✓ Per vernici, fondi, stucchi, legno, metallo, plastica
- ✓ Pretagliato
- ✓ Rotoli da 25 metri
- ✓ Grane disponibili: 180/240/320/400



Cod. art.



6439

CARTA ABRASIVA SOFT SPUGNA

SPUGNETTE ABRASIVE CAPEC-G

- ✓ Per legno e ferro
- ✓ Grana: fine, media, grossa
- ✓ Dimensioni: mm.100 x 70
- ✓ Spessore mm.25



SPUGNETTE ABRASIVE CAPEC-G

Cod. art.

6469.20

6469.22

6469.25

Grana

Fine 120

Media 60

Grossa 36

SPUGNETTE ABRASIVE CAPEC-S

- ✓ Per legno e ferro
- ✓ Grana: fine, media, grossa
- ✓ Dimensioni: mm.100 x 12,5
- ✓ Spessore mm.12



SPUGNETTE ABRASIVE CAPEC-S

Cod. art.

6469.26

6469.27

6469.28

Grana

Fine 120

Media 60

Grossa 36

PANNI ABRASIVI SPESSORATI

- ✓ Misura cm. 12 x 25
- ✓ Spessore mm. 25

Cod. art.	Modello
64410	Display assortito – 10 pz x tipo
64411	Bianco extra fine acciaio inox, vetro, pittura
64412	Beige grana fine metalli, plastica, legni
64413	Verde grana media per superfici prima della verniciatura
64414	Marrone grana grossa rimozione ruggine, pulizia legni
64415	Nero grana grossa ruggine e ossidazioni



PANNI ABRASIVI SPESSORATI

PANNI ABRASIVI SOTTILI

- ✓ Misura cm. 15 x 23
- ✓ Spessore mm. 6/7

Cod. art.	Modello
64400	Display assortito – 10 pz x tipo
64401	Bianco extra fine acciaio inox, vetro, pittura
64402	Antracite grana 1000 Metalli, Plastica, Legni
64403	Verde grana 800 per superfici prima della verniciatura
64404	Bordeaux grana 320 rimozione ruggine
64405	Beige grana 150 rimozione ruggine e ossidazioni



PANNI ABRASIVI SOTTILI

PANNI ABRASIVI SCOTCH BRITE

- ✓ Ideali per lavori di finitura su diversi materiali.



PANNI ABRASIVI SCOTCH BRITE

Cod. art.	6448	6449
Grana	Extra fine Grigio cm.28 x 12	Fine Rosso cm.28 x 12
Cod. art.	6450	
Grana	Fine Rosso cm.11 x 10 metri	



SPAZZOLA FRONTALE



- ✓ Filo in acciaio
- ✓ Utilizzo con trapano
- ✓ Ideali per lavori di pulizia
- ✓ **D: mm.25**
- ✓ **B: mm.20**
- ✓ **S: mm25**

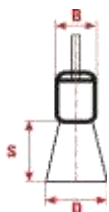

SPAZZOLA FRONTALE

Cod. art.

5598.1

SPAZZOLA A TAZZA



- ✓ Filo in acciaio
- ✓ Utilizzo con trapano
- ✓ Ideali per lavori di pulizia
- ✓ **S: mm.25**
- ✓ **D: mm.50**

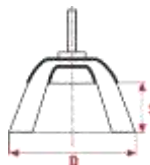

SPAZZOLA A TAZZA

Cod. art.

5598.4

5598.5

Misure

Ø 50 mm

Ø 75 mm

SPAZZOLA CIRCOLARE



- ✓ Filo in acciaio
- ✓ Utilizzo con trapano
- ✓ Ideali per lavori di pulizia
- ✓ **E: mm.5**
- ✓ **D: mm.50/75**

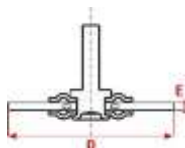

SPAZZOLA CIRCOLARE

Cod. art.

5598.2

5598.3

Misure

Ø 50 mm

Ø 75 mm

SPAZZOLA A TAZZA CRIMPATA

- ✓ Filo in acciaio
- ✓ Utilizzo con smerigliatrice
- ✓ Ideali per lavori di pulizia
- ✓ **F: M14**
- ✓ **S: mm.25**
- ✓ **D: mm.75/100**

12.500 min⁻¹ MAX. R.P.M x2



SPAZZOLA A TAZZA CRIMPATA

Cod. art.

5597.2

5597.4

Misure

Ø 75 mm

Ø 100 mm

SPAZZOLA A TAZZA CON NODO

- ✓ Filo in acciaio intrecciato
- ✓ Utilizzo con smerigliatrice
- ✓ Ideali per lavori di pulizia
- ✓ **D: mm.75**
- ✓ **F: M14**
- ✓ **S: mm.17**
- ✓ **Z: mm.18**

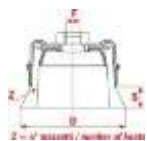

SPAZZOLA A TAZZA CON NODO

Cod. art.

5597.1

12.500 min⁻¹ MAX. R.P.M x2

SPAZZOLA CIRCOLARE CON NODO

- ✓ Filo in acciaio intrecciato
- ✓ Utilizzo con smerigliatrice
- ✓ Ideali per lavori di pulizia
- ✓ **D: mm.100**
- ✓ **F: M14**
- ✓ **S: mm.17**
- ✓ **Z: mm.18**

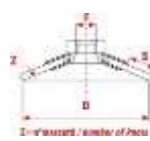

SPAZZOLA CIRCOLARE CON NODO

Cod. art.

5597.3

CARBIDE® Abrasive tools

CARATTERISTICHE:

- ✓ Durezza 95% rispetto al diamante e costo 4 volte inferiore
- ✓ Durata più di 150 volte rispetto alla carta vetrata
- ✓ Utilizzabile a secco o ad acqua
- ✓ Non intasa su superfici morbide
- ✓ Utilizzabile su qualsiasi smerigliatrice



UTILIZZO UNIVERSALE:

- Pietra
- Cemento
- Gesso
- Calcare
- Porfido
- Marmo
- Bitume
- Ceramica
- Pitture e vernici
- Cotto
- Feltro
- Lineum
- Gomma
- Epoxy
- Plastica
- Vetroresina
- PVC
- Legno
- Metallo



DISCHI CARBIDE ABRASIVE TOOLS

Cod. art.	64010	64011	64012
misura	Ø mm 115	Ø mm 115	Ø mm 115
Grana	14	24	36
Cod. art.	64015	64016	64017
misura	Ø mm 125	Ø mm 125	Ø mm 125
Grana	14	24	36
Cod. art.	64020	64021	64022
misura	Ø mm 180	Ø mm 180	Ø mm 180
Grana	14	24	36

SPAZZOLA MANUALE

- ✓ Filo in acciaio
- ✓ Ideali per lavori di pulizia

- ✓ L: cm.24,5
- ✓ A: cm.13,5
- ✓ S: mm.18
- ✓ E: mm.10

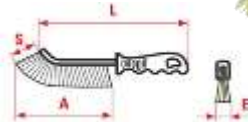

4902

Cod. art.

4902

SPAZZOLA MANUALE

- ✓ Filo in acciaio
- ✓ Ideali per lavori di pulizia

- ✓ L: cm.37
- ✓ A: cm.13,5
- ✓ S: mm.18
- ✓ E: mm.15

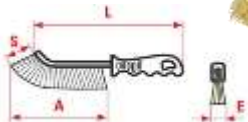

4903

Cod. art.

4903

SCROSTATORE AD AGHI

Trasforma tramite innesto rapido in soli 2 secondi , qualunque tipo di martello elettrico, batteria o pneumatico con mandrino SDS in uno scrostatore.

Scrostatura universale di ruggine, vernici, cemento, pietra, incrostazioni industriali, bocciardatura del marmo, frantumazione di fughe, invecchiamento del legno, manutenzione veicoli industriali, macchine agricole e movimento terra, mezzi militari, ferroviari, navali. rimozione di scorie da saldature, ecc..

Larghissimo impiego nel settore edilizia, per scrostatura tondini in ferro, e frantumazione meccanica di colle per piastrelle ed intonaci.



SCROSTATORE AD AGHI

Cod. art.	Modello
68091	12 aghi
68090	19 aghi



MOLLA PER SCROSTATORE AD AGHI



MOLLA PER SCROSTATORE AD AGHI

Cod. art.	Modello
SAA125	Molla x 12 aghi
SAA195	Molla x 19 aghi



AGHI DI RICAMBIO PER SCROSTATORE AD AGHI



AGHI DI RICAMBIO PER SCROSTATORE AD AGHI

Cod. art.	Modello
68096	KIT 12 aghi
68097	KIT 19 aghi



IMPUGNATURA PER SCROSTATORE AD AGHI



IMPUGNATURA PER SCROSTATORE AD AGHI

Cod. art.	Modello
68095	Impugnatura



DISCHI DA TAGLIO

DISCO TAGLIO CUTTING DISC



ALTA QUALITÀ

TAGLIO PULITO E VELOCE



DISCO TAGLIO CUTTING DISC

Cod. art.	5599.08	5599.07	5599.09	5599.10
Misura	115X1	115X1,2	115X1,6	115X3



DISCO MULTIFUNZIONE MULTI CUT

ALTA QUALITÀ

TAGLIO PULITO E VELOCE



DISCO MULTIFUNZIONE MULTI CUT

Cod. art.	5599.12	5599.11
Misura	115X1	115X1,6

- INOX
- FERRO
- ALLUMINIO
- PIETRA
- PVC
- CERAMICA



DISCO TAGLIO CUTTING DISC 230



ALTA QUALITÀ

TAGLIO PULITO E VELOCE

Cod. art.	5599.21	
Misura	230 x 2	DISCO TAGLIO CUTTING DISC 230



Abrasivi & taglio

DISCO REP 115

MULTI – COSTRUZIONE

- ✓ A corona incrociata per gres porcellanato, vetrificato e mosaico
- ✓ Misura mm.115 x 22

ALTA QUALITÀ



5599.50

Cod. art.

5599.50



DISCO REB 115

PER PIASTRELLE DIAMANTATO

- ✓ Per materiali edili in genere
- ✓ Utilizzabile su granito, marmo, pietra, porcellana
- ✓ Misura mm.115 x 22



5599.40

Cod. art.

5599.40

ALTA QUALITÀ



DISCO REU 115

TAGLIO DIAMANTATO MULTIMATERIALE

- ✓ Utilizzabile su asfalto, granito, marmo, porcellana
- ✓ Profondità di taglio non superiore a 2 cm
- ✓ Misura mm.115 x 22



5599.30

Cod. art.

5599.30

ALTA QUALITÀ



DISCO VELCRATO 125 8 FORI

Velcrato su carta abrasiva al corindone
Per superfici metalliche prima della verniciatura
Diametro mm. 125 - 8 fori

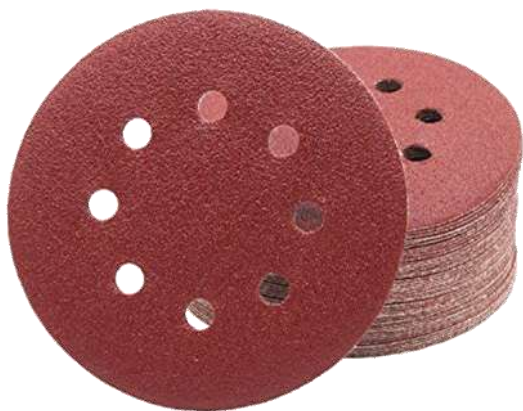

Cod. art.	Grana	Cod. art.	Grana
6436.040	40	6436.120	120
6436.060	60	6436.150	150
6436.080	80	6436.180	180
6436.100	100	6436.240	240

DISCO VELCRATO 15 FORI

Velcrato su carta abrasiva al corindone
Per superfici metalliche prima della verniciatura
Diametro mm. 150 - 15 fori



Cod. art.	Grana	Cod. art.	Grana
6437.040	40	6437.150	150
6437.060	60	6437.180	180
6437.080	80	6437.240	240
6437.100	100	6437.320	320
6437.120	120		

DISCO VELCRATO 200 8 FORI

Velcrato su carta abrasiva al corindone
Per superfici metalliche prima della verniciatura
Diametro mm. 200 - 8 fori



Cod. art.	Grana	Cod. art.	Grana
68050	40	68054	120
68051	60	68055	150
68052	80	68057	180
68053	100	68056	240

DISCO VELCRATO 225

Velcrato su carta abrasiva al corindone
Per superfici metalliche prima della verniciatura
Diametro mm. 225



Cod. art.	Grana	Cod. art.	Grana
68061	80	68064	150
68062	100	68065	180
68063	120	68066	220

DISCO VELCRATO 150 MESH X 313

Velcrato su retina poliammidica in alluminio OXIDE
Massima aspirazione delle polveri
Diametro mm. 150

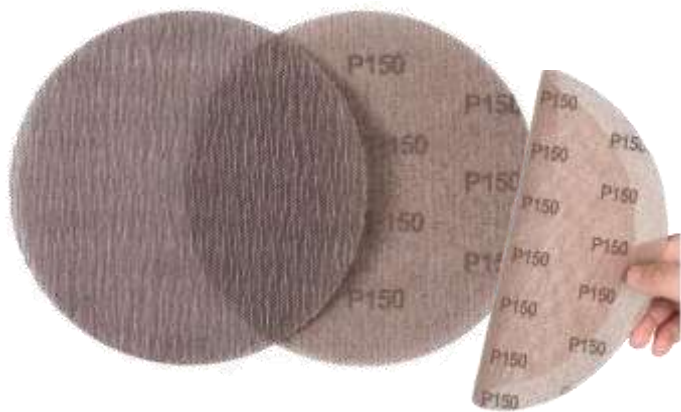

Cod. art.	Grana	Cod. art.	Grana
6438.08	80	6438.18	180
6438.10	100	6438.22	220
6438.12	120		
6438.15	150		



DISCO VELCRATO 225 MESH X 313

Velcrato su retina poliammidica Ceramic
Massima aspirazione delle polveri
Diametro mm. 225



Cod. art.	Grana	Cod. art.	Grana
6440.06	60	6440.15	150
6440.08	80	6440.18	180
6440.10	100	6440.22	220
6440.12	120		



DISCO VELCRATO SPUGNA MICROFORATO

Velcrato su carta abrasiva al corindone
Per superfici metalliche prima della verniciatura
Diametro mm. 220

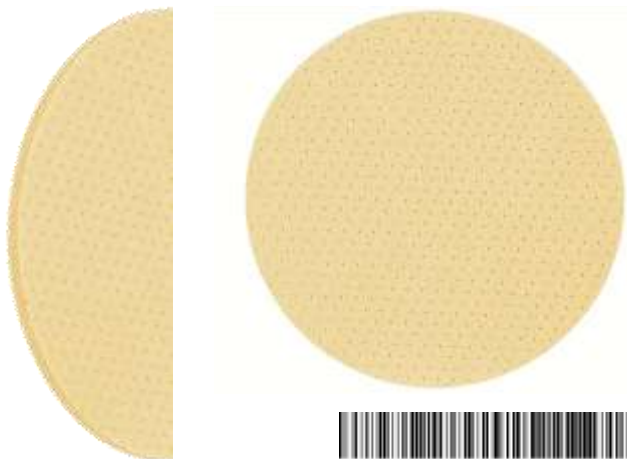

Cod. art.	Grana	Cod. art.	Grana
68071	60	68075	150
68072	80	68076	180
68073	100	68077	220
68074	120		

CUFFIA PER LUCIDARE

Sintetica con laccetti
Montata su tampone di spugna è ideale per la lucidatura
con paste abrasive



Cod. art.	misura
6541	∅ mm.180



Dispositivi di Protezione DPI

- Mascherine monouso
- Maschere con filtro
- Occhiali
- Visiere
- Guanti monouso
- Guanti da lavoro
- Tute monouso
- Nastri antiscivolo
- Nastri segnaletici
- Nastri rifrangenti



MONOUSO FFP1

- ✓ Per polveri, fumi ed aerosol non organici a bassa nocività



54780

Cod. art.

54780

MONOUSO FFP1

- ✓ Per polveri, fumi ed aerosol non organici a bassa nocività
- ✓ Con valvola
- ✓ A conchiglia



54781

Cod. art.

54781

MONOUSO FFP1

- ✓ Per polveri, fumi ed aerosol non organici a bassa nocività
- ✓ Pieghevole



54800

Cod. art.

54800

MONOUSO FFP1

- ✓ Per polveri, fumi ed aerosol non organici a bassa nocività
- ✓ Con valvola, pieghevole



54801

Cod. art.

54801

MONOUSO FFP2

- ✓ Per polveri, fumi ed aerosol non organici a bassa nocività
- ✓ Pieghevole



54810

Cod. art.

54810

MONOUSO FFP2

- ✓ Per polveri, fumi ed aerosol non organici a bassa nocività
- ✓ Con valvola
- ✓ A conchiglia



54811

Cod. art.

54811

FACCIALE FILTRANTE

MONOUSO FFP3

- ✓ Per polveri, fumi ed aerosol non organici a bassa nocività
- ✓ Con valvola
- ✓ A conchiglia



54820

Cod. art.

54820



MONOUSO FFP2

- ✓ (efficacia filtrante totale minima pari al 92%).
- ✓ Inibisce gli odori sgradevoli dovuti a vernici, resine poliesteri, carburanti e per la rimozione di vernici e adesivi. **A carboni attivi**



54812

Cod. art.

54812



SEMI MASCHERA FILTRANTE

- ✓ Conforme alla norma europea EN140:1998
- ✓ Idonea per la protezione da polveri
- ✓ Modello a 2 filtri



SEMI MASCHERA FILTRANTE

Cod. art.

6470

6471

Modello

1 filtri

2 filtri



CARTUCCE A FILTRO

Tipologia d'uso delle cartucce:

A1 = gas, vapori organici, solventi

B1 = gas, vapori organici tipo: cloro, acido cianidrico, idrogeno solforato.

E1 = gas acidi, anidride solforosa, cloruro di idrogeno.

P2 = polveri non tossiche

K1 = ammoniaca

P3 = Filtri per aerosol solidi e liquidi, polveri, fumi e nebbie.



CARTUCCE A FILTRO

Cod. art.

6474

6475

6476

6477

Modello

A1-P2R

P3R

P2R

A1-B1-E1-K1



OCCHIALE MDELLO BARI

- ✓ Trattamento anti appannante
- ✓ Anti graffio
- ✓ Stanghette regolabili



54855

Cod. art.

54855

OCCHIALE MDELLO NICE

- ✓ Trattamento anti appannante
- ✓ Anti graffio
- ✓ Campo visivo laterale



54860

Cod. art.

54860

MASCHERA

- ✓ Montatura in PVC flessibile
- ✓ Protezione UV al 99%
- ✓ Ventilazione diretta



54870

Cod. art.

54870

VISIERA

- ✓ In polietilene
- ✓ Conforme EN166:2002



58870

Cod. art.

58870

GUANTO NITRILE DOC NERO

- ✓ Monouso ambidestro non sterile
- ✓ Privo di talcatura
- ✓ Ad uso contatto alimentare



Cod. art. 67400 67401 67402 67403

Taglia S M L XL

GUANTO NITRILE EKO ZERO

- ✓ Monouso ambidestro non sterile
- ✓ Certificati per uso medico sanitario



Cod. art. 6759 6760 6761 6762

Taglia S M L XL

GUANTO NITRILE EKO GRIP

- ✓ Monouso ambidestro non sterile
- ✓ Privo di talcatura
- ✓ Superficie microruvida per una presa ottimale



Cod. art. 67411 67412 67413 67414

Taglia M L XL XXL

GUANTO NITRILE EKO GRIP

- ✓ Monouso ambidestro non sterile
- ✓ Privo di talcatura
- ✓ Superficie microruvida per una presa ottimale



Cod. art. 67416 67417 67418

Taglia M L XL

GUANTO LATTICE HIGHT RISK

- ✓ Monouso ambidestro non sterile
- ✓ Privo di talcatura
- ✓ Spessore e lunghezza maggiorata



Cod. art. 6764 6765 6766 6767

Taglia S M L XL

GUANTO LATTICE EXTRA LIGHT

- ✓ Monouso ambidestro con orletto
- ✓ Con talcatura



Cod. art. 6754 6755 6756 6757

Taglia S M L XL

GUANTO NYLON SPALMATO



GUANTO NYLON SPALMATO

6773	6774	6775	6776	67761
Tg. 7	Tg. 8	Tg. 9	Tg. 10	Tg. 11

GUANTO POLIURETANO SPALMATO B



6769	6770	6771	6772
Tg. 7	Tg. 8	Tg. 9	Tg. 10

GUANTO POLIURETANO SPALMATO N



6777	6778	6779	6780
Tg. 7	Tg. 8	Tg. 9	Tg. 10

GUANTO IN PELLE FIORE BOVINA



GUANTO IN PELLE FIORE BOVINA

56842	56843	56844	56845
Tg. 8	Tg. 9	Tg. 10	Tg. 11

GUANTO ANTITAGLIO



67460	67461	67462	67463
Tg. 8	Tg. 9	Tg. 10	Tg. 11

GUANTO NITRILE SPALMATO



67450	67451	67452	67453
Tg. 8	Tg. 9	Tg. 10	Tg. 11

GUANTO LATTICE SPALMATO



GUANTO LATTICE SPALMATO

67681	67682	67683
Tg. 8	Tg. 9	Tg. 10

TUTA DI PROTEZIONE CAT.5



6738 L	6738 XL	6738 XXL
L	XL	XXL

TUTA DI PROTEZIONE BASIC



6737 L	6737 XL	6737 XXL
L	XL	XXL

NASTRO ANTISCIVOLO GIALLO-NERO

- ✓ Spessore 60 grit
- ✓ Resistenti allo scivolamento
- ✓ UNI EN 16165:2021 e DIN EN 16165:2023-02
- ✓ Classificazione R13
- ✓ GIALLO/NERO



Cod. art. **6665**

misura mm 25 x 5 mt



NASTRO ANTISCIVOLO TRASPARENTE

- ✓ Spessore 60 grit
- ✓ Resistenti allo scivolamento
- ✓ UNI EN 16165:2021 e DIN EN 16165:2023-02
- ✓ Classificazione R13 – con adesivo
- ✓ TRASPARENTE



Cod. art. **6664**

misura mm.19 x 18 metri



NASTRO ANTISCIVOLO NERO

- ✓ Spessore 60 grit
- ✓ Resistenti allo scivolamento
- ✓ UNI EN 16165:2021 e DIN EN 16165:2023-02
- ✓ Classificazione R13 – con adesivo
- ✓ Misura: rotoli da 15 metri



Cod. art. **6661** **6662** **6663**

misura mm.19 mm.25 mm.50



NASTRO SEGNALETICO

- ✓ Nastro omologato per cantieri ad alta visibilità per delimitare aree interdette o pericolose
- ✓ Resistente ai raggi UV



Cod. art. **6800**

Formato mm.50x200mt



NASTRO ADESIVO BICOLORE ROSSO-BIANCO

- ✓ Colore **BIANCO/ROSSO**
- ✓ Adesione forte e rapida
- ✓ Spessore 160,0 micron



Cod. art. **64540**

misura mm 50 X 50 mt



NASTRO ADESIVO BICOLORE GIALLO-NERO

- ✓ Colore **GIALLO/NERO**
- ✓ Adesione forte e rapida
- ✓ Spessore 160,0 micron



Cod. art. **64541**

misura mm 50 X 50 mt



NASTRO ADESIVO RIFLETTENTE

- ✓ Adesivo, impermeabile, catarifrangente in PVC
- ✓ Ad alta intensità, per auto e moto
- ✓ **Misura: mm. 50 x 12,5 metri**



Cod. art. **64542** **64543** **64544**

Colore Bianco Rosso Giallo



NASTRO ADESIVO RIFRANGENTE

- ✓ Cl.1 Attraverso l'affiancamento dei due nastri si ottiene una figura a spina di pesce.
- ✓ **Misura: mm. 50 x 11,5 metri**



Cod. art. **64546** **64547**

Colore Giallo/nero Bianco/rosso



Elettrotensili

- Levigatrici a muro
- Bidoni aspiratutto
- Pistola a spruzzo
- Miscelatore
- Coltelli a caldo per polistirolo
- Taglierina a caldo per polistirolo
- Ricambi



LEVIGATRICE A SECCO RTR3793

- ✓ Potenza 710w
- ✓ Dimensioni del disco levigante r
- ✓ Giri a vuoto 1000 – 2100 rpm
- ✓ Voltaggio 230 V
- ✓ Frequenza 50 Hz
- ✓ Peso netto 4,30 kg.



LEVIGATRICE A SECCO RTR3793

Cod. art.

68004



RTRMAX

UNION SMALL SANDER 21

Innovative levigatrici a corto raggio 230 V - 1500 W trasmissione diretta, tripla riduzione meccanica e controllo takimetrico di coppia 700 – 2500 rpm per abrasivi max 200 mm, dischi diamantati e max PCD 150 mm.

Utilizzo: Levigatura di qualunque superficie, muri, cartongesso, legno con dischi abrasivi da 150 / 200 mm, levigatura marmo, cemento e colle con dischi diamantati da 150 / 180 mm.

Con dischi in PCD da 150 / 180 mm in grado di rimuovere in alternativa allo sverniciatore in circa 3 min. 1 mq di vernice termo plastica o al quarzo, utensile unico e pionieristico ergonomico ed estremamente affidabile, che permette all'operatore agli attuali prezzi di mercato, di ammortizzare il costo dopo soli 100 mq e in circa 5 ore di lavoro.



UNION SMALL SILENT SANDER

Cod. art.

68011



UNION TOOLS PATENT

ASPIRATORE RTM8030

- ✓ Omologazione CE
- ✓ Potenza in ingresso 1400 W
- ✓ Carico Max. presa Esterna 2000W
- ✓ Capacità serbatoio 30 litri
- ✓ Classe di protezione IPX4
- ✓ Voltaggio 230V
- ✓ Frequenza 50 Hz
- ✓ Peso Netto 6,50 kg.

RTRMAX



Cod. art.



ASPIRATORE RTM8030

68005

ASPIRATORE GISOWATT PC35

- ✓ Potenza 1100W
- ✓ Capacità 35 litri
- ✓ Maggiori dettagli in scheda tecnica



Cod. art.



ASPIRATORE GISOWATT PC35

68100

ASPIRATORE GISOWATT PC35 TOOLS NV

- ✓ Potenza 1000W
- ✓ Capacità 35 litri
- ✓ Maggiori dettagli in scheda tecnica



Cod. art.



ASPIRATORE GISOWATT PC35 TOOLS NV

68105

DUST BOX – SEPARATORE DI POLVERI

- ✓ Dust Box è un separatore di polvere evoluto che consente di operare in un ambiente più sicuro e lasciare il proprio aspiratore sempre efficiente.



Cod. art.



DUST BOX SEPARATORE DI POLVERI

68106

TAGLIERINA A FILO CALDO PER POLISTIROLO

- ✓ Taglierina professionale con taglio in altezza 120 cm (200W).
- ✓ Taglierine scorrevoli e inclinabili che permettono di tagliare pannelli con profondità di 30 cm
- ✓ Il cavalletto con ruote non è in dotazione.



Cod. art.

80101

RICAMBI PER TAGLIERINA



FILO A CALDO
CODICE 80104



ALIMENTATORE
CODICE 80108



GANCIO/SUPPORTO
PER PONTEGGI
CODICE 80106



CAVALLETTO
CON RUOTE
CODICE 80105



GUIDE SCORREVOLI
CODICE 80103



COLTELLO A CALDO BASE – UCC2012



Innovativo coltello a caldo ergonomico, bilanciato e plurifunzionale, 230 v – 130w – 2.5v

Taglio polistirolo, sughero, lana roccia.

In dotazione:

- ✓ 1 Lama Da Mm.150
- ✓ 1 Punta Da Mm.120
- ✓ 1 Supporto inox direzionale
- ✓ Con valigetta

Cod. art.



UCC2012



COLTELLO A CALDO BASE – UCC2012KIT



Innovativo coltello a caldo ergonomico, bilanciato e plurifunzionale, 230 v – 130w – 2.5v operativo in 15 secondi

Taglio polistirolo, sughero, lana roccia.

In dotazione con valigetta:

- ✓ 1 Lama da mm.150 - 1 lama da mm.120
- ✓ 1 Supporto inox direzionale
- ✓ 1 Slitta per incassi
- ✓ 3 Profili sagomati per lisene
- ✓ 1 Filo da mm.300 modulabile

Cod. art.



UCC2012KIT2



PISTOLA A SPRUZZO HVLP

- ✓ Potenza in ingresso 650 W
- ✓ Tensione 220-240 V Frequenza 50/60Hz
- ✓ Serbatoio Capacità 800 ml
- ✓ Max Viscosità 60din/sec
- ✓ Max flusso 800 ml/min
- ✓ Ugello F1,8/2,6 mm
- ✓ Peso netto 2,2 kg
- ✓ Cavo approvato VDE da 2 metri

Cod. art.



68001

68001



TOLSEN

MISCELATORE ELETTRONICO

- ✓ Miscelatore con cambio a due velocità e controllo della velocità variabile.
- ✓ VOLTAGGIO: 230V /50hz
- ✓ Potenza: 1800 w
- ✓ Velocità: 1 marcia 0 – 430 rpm 2 marcia 0 – 750 rpm
- ✓ PESO: 6,5 kg.
- ✓ Fruste consigliate: 120/140 mm (non in dotazione)

Cod. art.



68117

68117

GRÖNE



LIANTONIO
VERNICI

INTERFACCIA
PER CARTEGGIATRICE
Per disco da mm.200



68040

Cod. art.

68040



CAMPANA DI ASPIRAZIONE
PER CARTEGGIATRICE
Per disco da mm.200



CAMPANA DI ASPIRAZIONE

Cod. art.

68080
CAMPANA

68081
SPAZZOLA



KIT CAVO DI TRASMISSIONE
PER CARTEGGIATRICE SILENT



68032

Cod. art.

68032



FLANGE + VITE PER DISCHI DIAMANTATI



64050

Cod. art.

64050



CARTUCCIA/FILTRO PER ASPIRATORE
PC35TOOLS



68009

Cod. art.

68009



SACCHI PER ASPIRATORE
PC35 TOOLS
Box da 5 pezzi



68115

Cod. art.

68115



FILTRO/SACCO PER ASPIRATORE
PC35 TOOLS



68009L

Cod. art.

68009 L



PREFILTRO PER SEPARATORE DI POLVERI
Box da 5 pezzi



68106F

Cod. art.

68106 F



LAME PER COLTELLO A FILO CALDO - KIT



UKITPL

Cod. art.

UKITPL

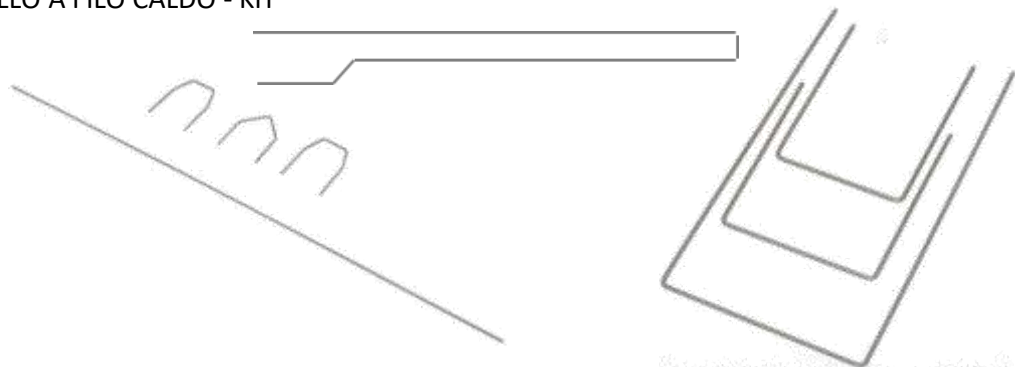

Scale & Ponteggi

- Scale domestiche
- Scale pittore
- Scale telescopiche
- Sgabelli
- Trabattelli
- Ponteggi a torre



TIZETA

FACAL
SISTEMI PER LA SICUREZZA

SC
SCALIFICIO CANNAROZZI

DUPLA è scala tutta in alluminio a doppia salita a gradini larghi profondi 85 mm su ambo i lati fissati ai montanti con doppio passaggio idraulico senza rivetti.



DOPPIA SCALA DUPLA

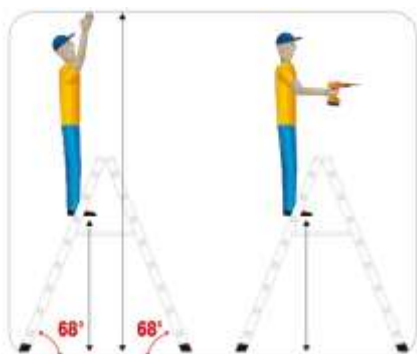

CORRETTA
 POSIZIONE
 DI LAVORO



COD. ARTICOLO	ALTEZZA TOTALE cm.	AMPIEZZA APERTURA cm.	LARGHEZZA BASE cm.	Altezza di lavoro cm.	SCALA CHIUSA cm.	GRADINI + Pianetto	PESO Kg.
6090	130	113	50	255	141	5	7,8
6091	154	125	53,5	279	166	6	9,0
6092	176	144	56	303	190	7	10,4
6093	199	169	59,5	327	215	8	11,8
6095	249	197	65,5	375	265	10	14,8
6096	297	220	72	421	315	12	17,8

"PITTORE"
 ...l'amico di legno

PITTORE Scale da lavoro con montanti in legno di pino 25x60 mm e pioli in faggio. Verniciate in trasparenza.



DOPPIA SCALA PITTORE

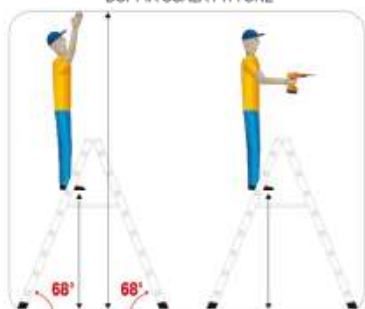

CORRETTA
 POSIZIONE
 DI LAVORO



COD. ARTICOLO	ALTEZZA TOTALE cm.			Altezza di lavoro cm.	SCALA CHIUSA cm.	GRADINI + Pianetto	PESO Kg.
6130.06	160	-	-	270	168,5	6	5,5
6130.07	186,5	-	-	296	196,5	7	11
6130.08	212,5	-	-	322	223	8	12,3
6130.09	238	-	-	348	250	9	13,5



SCALA UNIVERSALE BRIKO BLU

150 kg
MAX

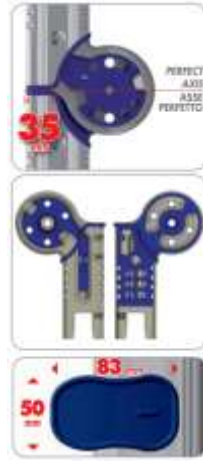

CODICE	ALTEZZA PERTA cm.	Appoggio a muro cm.	ALTEZZA AVORO cm.	SCALA CHIUSA cm.	ALTEZZA A FILO cm.	GRADINI	PESO Kg.
6150	143	380	260	92	288	3+3	9,5
6151	198	490	315	120	400	4+4	12,50
6152	225	550	340	148	456	4+5	13
6153	252	605	370	148	512	5+5	14

EUROBRIKO16 è scala universale tutta in alluminio di superiori qualità tecniche a conferma di prodotto unico.



SCALA UNIVERSALE EURO BRIKO 16

150 kg
MAX

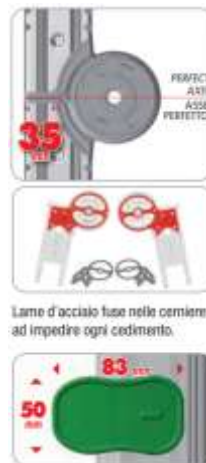

CODICE	Altezza aperta cm.	Larghezza base cm.	Appoggio cm.	Altezza lavoro cm.	Scala chiusa cm.	Altezza a filo cm.	GRADINI	PESO Kg.
6154	280	167	660	390	176	570	6+6	16,50



CLIC Trabattello d'alluminio a due alzate con innesti d'acciaio rivestiti di speciali resine. Collegamenti orizzontali e diagonali istantanei con espansori nei fori dei gradini. Lunghie leve di facile uso.

- ✓ Montanti: 24x60 mm
- ✓ Gradini: 30x30 mm
- ✓ Base: 114x156 cm.
- ✓ Struttura: 58x156 cm.
- ✓ Piano di lavoro: 51x143 cm.
- ✓ Sopralzo: 6 gradini
- ✓ **Altezza totale della torre metri 3,65**



Cod. art. **6170**

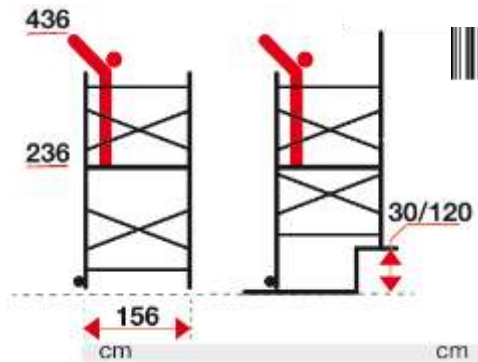

Piano in alluminio e legno artificiale, idrossolente, antiscivolo.



PROLUNGA in alluminio a 7 gradini da applicare al trabattello **CLIC**. Collegamenti orizzontali e diagonali istantanei con espansori nei fori dei gradini. Lunghie leve di facile uso.

- ✓ 4 Stabilizzatori automatici
- ✓ 1 Piano di lavoro
- ✓ Peso kg.33
- ✓ **Altezza totale con Clic + Clac metri 5,65**

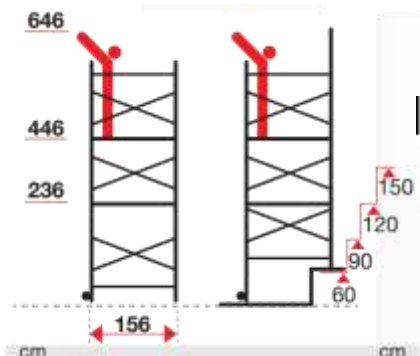

Cod. art. **6171**



TRABATTELLO SUPER

TIZETA

Trabattello "Super", indispensabile per le piccole manutenzioni domestiche, facile da trasportare, minimo ingombro, confezionato in termoretraibile, rapidissimo da montare, passa attraverso le porte senza nessuna azione di schiacciamento o smontaggio.

CARATTERISTICHE TECNICHE

In acciaio zincato

Montanti da Ø 30 mm

Completo di piano di lavoro

Dimensioni della base cm. 146 x 70

Altezza metri 1,85

Dotato di 2 ruote per facilitarne lo spostamento

Portata massima kg.150

Codice articolo 6174



TRABATTELLO SUPER



TRABATTELLO SUPER

«SPECIAL»

TIZETA

Trabattello "Super Special", indispensabile per le piccole manutenzioni domestiche, facile da trasportare, minimo ingombro, confezionato in termoretraibile, rapidissimo da montare, passa attraverso le porte senza nessuna azione di schiacciamento o smontaggio.

CARATTERISTICHE TECNICHE

In acciaio zincato

Montanti da Ø 30 mm

Completo di piano di lavoro

Dimensioni della base cm. 146 x 70

Altezza metri 2,30

Dotato di 2 ruote per facilitarne lo spostamento

Portata massima kg.150

codice articolo 6175



TRABATTELLO SUPER SPECIAL





SCALA ALFA

Scala europea in alluminio con unica rampa di salita.
 Prodotta da impianti industriali di elevata tecnologia.
 Montanti tubolari in alluminio di mm 42x20 nella parte anteriore
 e di mm 35x20 nella parte posteriore.
 Gradini profondi 82 mm fissati ai montanti con tecnica auto perforante.



Tecnica auto perforante

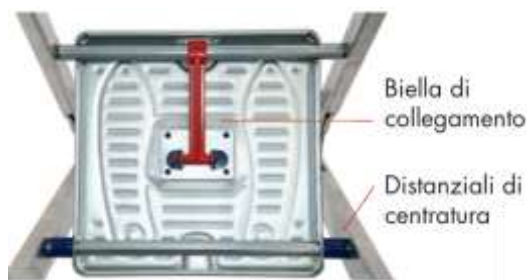

Biella di collegamento
 Distanziali di centratura



Piedi antiscivolo PVC



Cinghie di sicurezza
In poliestere a partire da 5 gradini

Ampiezza gradino



Terminali ABS



COD. ARTICOLO	ALTEZZA TOTALE metri	AMPIEZZA APERTURA cm.	LARGHEZZA BASE cm.	ULTIMO RIPIANO cm.	SCALA CHIUSA cm.	GRADINI	PESO Kg.
9703	1,23	66	0,41	0,63	137	3	3,6
9704	1,45	82	0,44	0,88	459	4	4,2
9705	1,66	97	0,46	1,07	181	5	4,8
9706	1,88	112	0,49	1,28	204	6	5,6
9707	2,10	128	0,51	1,49	227	7	7,0
9708	2,32	142	0,53	1,72	249	8	7,8



GAMMA Maxi



Scala europea in alluminio con unica rampa di salita. Prodotta da impianti industriali di elevata tecnologia.
 Montanti tubolari in alluminio di mm 42x20 nella parte anteriore e di mm 35x20 nella parte posteriore.
 Gradini MAXI PROFONDI 120 mm fissati ai montanti con tecnica autoperforante.



Tecnica autoperforante



300x140
mm

Vasca porta oggetti compresa



Piedi antiscivolo PVC



Gradini profondi 120 mm.
Fissati ai montanti con tecnica autoperforante



Cinghie di sicurezza in poliestere a partire da 5 gradini



Biella di collegamento



COD. ARTICOLO	ALTEZZA TOTALE cm.	AMPIEZZA APERTURA cm.	LARGHEZZA BASE cm.	ULTIMO RIPIANO cm.	SCALA CHIUSA cm.	GRADINI	PESO Kg.
9805	166	97	0,46	105	181	5	5,4
9806	188	112	0,49	127	204	6	6,4
9807	210	128	0,51	149	227	7	7,4
9808	232	142	0,53	171	249	8	8,8

Tinto

Sgabello d'acciaio in tubolare 20x15 mm. Gradini acciaio 20x30 cm.
Verniciato con brillanti polveri epossidiche nei colori:



SGABELLO TINTO



TELAIO

GRADINI

PLASTICHE



COD. ARTICOLO	ALTEZZA TOTALE	AMPIEZZA APERTURA	LARGHEZZA BASE	ULTIMO RIPIANO	SCALA CHIUSA	GRADINI	PESO Kg.
9720	cm.81,5	cm.56,5	cm.46	cm.50	cm.89	2	4,0
9721	cm.104,5	cm.75	cm.46	cm.75	cm.114	3	6,0
9722	cm.126,5	cm.82	cm.46	cm.100	cm.141	4	7,8



Sgabello di alluminio in tubolare Ø 28 mm anteriore e Ø 25 mm posteriore, colore grigio. Gradini ricoperti in gomma antiscivolo nera 37x25 cm



SGABELLO SUPER EFFE



COD. ARTICOLO	ALTEZZA TOTALE	AMPIEZZA APERTURA	LARGHEZZA BASE	ULTIMO RIPIANO	SCALA CHIUSA	GRADINI	PESO Kg.
9725	cm.106	cm.54	cm.52	cm.48	cm.113	2	5,6
9726	cm.132	cm.72	cm.54	cm.72	cm.139	3	7,6
9727	cm.158	cm.90	cm.56	cm.97	cm.165	4	9,4



Sgabello di altissima qualità, con montanti interamente in alluminio verniciato, adatto per l'uso domestico. Semplice da utilizzare e di rapida pulizia, presenta un'ampia pedana su cui poter svolgere le quotidiane faccende domestiche e non solo. I dettagli sono curati con meticolosità e puntualmente, per rendere lo sgabello unico nel suo genere.



PIEDI ANTISCIVOLO

- Caratteristiche tecniche principali:**
- Montante anteriore 50x20 mm
 - Montante posteriore 35x20 mm
 - Ampiezza pedana 21x35 cm
 - Verniciato bianco o in alluminio naturale



SGABELLO CANNAROZZI



PEDANA ANTISCIVOLO



TRAVERSINI DI RINFORZO



COD. ARTICOLO	ALTEZZA TOTALE cm.	AMPIEZZA APERTURA cm.	LARGHEZZA BASE cm.	ULTIMO RIPIANO cm.	SCALA CHIUSA cm.	GRADINI	PESO Kg.
9712	110	0,52	0,44	0,49	0,11	2	4,5
9713	134	0,67	0,45	0,75	0,11	3	5,5
9714	162	0,84	0,46	1,01	0,11	4	6,5
9715	190	1,00	0,47	1,27	0,11	5	7,5

CARATTERISTICHE TECNICHE

- Montanti in tubo acciaio \varnothing mm 45 x 1,5
- Ruote girevoli \varnothing mm 200 di cui 2 con freno
- Dimensioni base senza stabilizzatori cm 120 x 200
- Zincatura elettrolitica

- **Altezza massima raggiungibile mt 14,85**

- Altezza massima piano di lavoro mt 13,70

COMPOSIZIONE BASE

- N° 2 telai con piastre e ruote \varnothing mm 200
- N° 2 collegamenti in tubo quadrato cm 192,2 di lunghezza
- N° 4 stabilizzatori con piattello \varnothing mm 160
- Altezza base con ruote cm 45
- Peso base con stabilizzatori Kg.50

COMPOSIZIONE SOPRALZO

- Altezza cm 160 (pezzi 2 montanti o spalle)
- N° 2 laterali di collegamento
- N° 4 aste di controventatura
- Peso sopralzo: Kg 27

TIZETA



ACCESSORI NON INCLUSI

Piano di lavoro con botola e tavole fermapiedi cm.189,5 x 110 – peso kg.43 (portata max kg.200 compresa una persona)

Coppia di parapetti da posizionare ad almeno cm 100 dal piano di lavoro peso kg.6

Staffe/barre laterali da mt 2 di altezza

Scala di accesso da cm 200 di altezza peso kg.7,40

Cod. 6191



Piano di lavoro +
Tavole fermapiedi

Cod. 6194



Coppia parapetti

Cod. 6196



Staffe/Barre
laterali

Cod. 6193



Scala

Cod. 6192



Sopralzo

Cod. 6190



Base

Composizione Trabattello EXTRATOP



 Portata max per piano di lavoro kg.200	Peso totale della torre Kg.77	Peso totale della torre Kg.104	Peso totale della torre Kg.131	Peso totale della torre Kg.158	Peso totale della torre Kg.185	Peso totale della torre Kg.212	Peso totale della torre Kg.239	Peso totale della torre Kg.266	Peso totale della torre Kg.293
	        	mt. 2,05	mt. 3,65	mt. 5,25	mt. 6,85	mt. 8,45	mt. 10,05	mt. 11,65	mt. 13,25
Altezza Max Piano di lavoro	mt. 1,05	mt. 2,65	mt. 4,25	mt. 5,85	mt. 7,45	mt. 9,05	mt. 10,65	mt. 12,25	mt. 13,25
Base completa di 4 stabilizzatori	PZ.1	PZ.1	PZ.1	PZ.1	PZ.1	PZ.1	PZ.1	PZ.1	PZ.1
Sopralzo di cm.160	PZ.1	PZ.2	PZ.3	PZ.4	PZ.5	PZ.6	PZ.7	PZ.8	PZ.9

CARATTERISTICHE TECNICHE

- Montanti in tubo acciaio \varnothing mm 42 x 1,5
- Ruote girevoli \varnothing mm 200 di cui 2 con freno
- Dimensioni base senza stabilizzatori cm 100 x 200
- Zincatura elettrolitica

- **Altezza massima raggiungibile mt 10,05**

- Altezza massima piano di lavoro mt 8,90

COMPOSIZIONE BASE

- N° 2 telai con piastre e ruote \varnothing mm 200
- N° 2 collegamenti in tubo quadrato cm 192,2 di lunghezza
- N° 4 stabilizzatori con piattello \varnothing mm 160
- Altezza base con ruote cm 44
- Peso base con stabilizzatori Kg 48

COMPOSIZIONE SOPRALZO

- Altezza cm 160 (pezzi 2 montanti o spalle)
- N° 2 laterali di collegamento
- N° 4 aste di controventatura
- Peso sopralzo: Kg.18,50

ACCESSORI NON INCLUSI

Piano di lavoro con botola e tavole fermapiedi cm.189,5 x 110 – peso kg.39 (portata max kg.200 compresa una persona)

Coppia di parapetti da posizionare a cm 100 dal piano di lavoro peso kg.6

Barra stabilizzatrice laterali da mt 2 di altezza peso kg.5,50

Scala di accesso da cm 204 di altezza peso kg.7,40

TIZETA



Cod. 6191.1

Cod. 6194

Cod. 6196

Cod. 6193

Cod. 6197

Cod. 6195



Piano di lavoro +
Tavole fermapiedi



Coppia parapetti



Staffe/Barre
laterali



Scala





Sopralzo



Base

Composizione Trabattello SUPERTOP

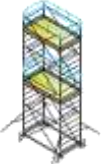

 Portata max per piano di lavoro kg.200	Peso totale della torre Kg.73	Peso totale della torre Kg.98	Peso totale della torre Kg.123	Peso totale della torre Kg.148	Peso totale della torre Kg.173	Peso totale della torre Kg.198
						
Altezza struttura	mt. 2,05	mt. 3,65	mt. 5,25	mt. 6,85	mt. 8,45	mt. 10,05
Altezza Max Piano di lavoro	mt. 1,05	mt. 2,65	mt. 4,25	mt. 5,85	mt. 7,45	mt. 9,05
Base completa di 4 stabilizzatori	PZ.1	PZ.1	PZ.1	PZ.1	PZ.1	PZ.1
Sopralzo di cm.160	PZ.1	PZ.2	PZ.3	PZ.4	PZ.5	PZ.6

CARATTERISTICHE TECNICHE

- Montanti in tubo acciaio \varnothing mm 42 x 1,5
- Ruote girevoli \varnothing mm 125 di cui 2 con freno
- Dimensioni base senza stabilizzatori cm 92 x 178
- Zincatura elettrolitica
- **Altezza massima raggiungibile mt 6,80**



- Altezza massima piano di lavoro mt 5,70

COMPOSIZIONE BASE

- N° 2 telai con piastre e ruote \varnothing mm 125
- N° 2 collegamenti in tubo rettangolare
- N° 4 stabilizzatori con piattello \varnothing mm 95
- Altezza base con ruote cm 40
- Peso base con stabilizzatori Kg 26

COMPOSIZIONE SOPRALZO

- Altezza cm 160 (pezzi 2 montanti o spalle) peso kg.16
- N° 2 laterali di collegamento
- N° 4 aste di controventatura
- Peso sopralzo: Kg 23

ACCESSORI NON INCLUSI

Piano di lavoro con botola e tavole fermapiedi cm.165,5 x 83 – peso kg.33 (portata max kg.150 compresa una persona)

Coppia di parapetti da posizionare ad almeno cm 100 dal piano di lavoro peso kg.5,50

Barra stabilizzatrice laterali da mt 2 di altezza peso kg.5,50

Scala di accesso da cm 204 di altezza peso kg.7,40



Cod. 6178.6

Cod. 6178.7

Cod. 6196

Cod. 6193

Cod. 6178.5

Cod. 6178.4



Piano di lavoro +
Tavole fermapiedi



Coppia parapetti



Staffe/Barre
laterali



Scala





Sopralzo



Base

Composizione Trabattello **VERSILIA**

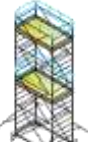
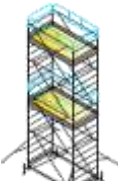

 Portata max per piano di lavoro kg.200	Peso totale della torre Kg.48	Peso totale della torre Kg.70	Peso totale della torre Kg.92	Peso totale della torre Kg.114
				
Altezza struttura	mt. 2,05	mt. 3,65	mt. 5,25	mt. 6,85
Altezza Max Piano di lavoro	mt. 1,05	mt. 2,65	mt. 4,25	mt. 5,85
Base completa di 4 stabilizzatori	PZ.1	PZ.1	PZ.1	PZ.1
Sopralzo di cm.160	PZ.1	PZ.2	PZ.3	PZ.4

CARATTERISTICHE TECNICHE

- Montanti in tubo acciaio zincato \varnothing mm 30 x 1,5
- Ruote girevoli \varnothing mm.100 di cui 2 con freno
- Altezza base cm.40
- Zincatura elettrolitica
- Portata piano di lavoro kg.130
- Altezza massima raggiungibile mt.3,20
- Altezza massima piano di lavoro mt.2,20
- Dimensioni struttura cm.75x181

COMPOSIZIONE BASE NORMALE

- N°2 telai con 2 ruote \varnothing 100 montate

COMPOSIZIONE SOPRALZO

- N°2 montanti o spalle
- N°2 laterali di collegamento



ACCESSORI NON INCLUSI

Piano di lavoro in 1 pezzo



TRABATTELO 035 TOP MOD.320



Cod. art. **6180.320**

Cod.6188	Cod.6187	Cod.6185	Cod.6180
			
Piano di lavoro Con botola cm.181x68	Coppia terminali	Sopralzo	Base normale

Composizione Trabattello TOP 035

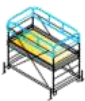

TRABATTELO 035 TOP MOD.180

	Peso totale della torre Kg.23,80	Peso totale della torre Kg.39,80
Portata max per piano di lavoro kg.150	CODICE 6180.180	CODICE 6180.320
		
Altezza struttura	mt. 1,80	mt. 3,20
Altezza Max Piano di lavoro	mt. 0,80	mt. 2,20
Base normale Peso kg.5	PZ.1	PZ.1
Sopralzo di m.160 peso kg.16	PZ.1	PZ.2
Coppia terminali Peso kg.2,80	PZ.1	PZ.1



Cod. art. **6180.180**

TRABATTELLO *Mito*

CARATTERISTICHE TECNICHE

- Trabattello in acciaio zincato \varnothing mm 35 x 1,5
- Conforme a D.Lgs 81/2008
- Dimensioni contenute e semplicità d'uso per interni industriali, negozi o vani scale con l'accessorio zoppo.
- Le saette diagonali sono unico corpo con le traverse orizzontali.

• **Altezza massima raggiungibile mt 3,90**

• Altezza massima piano di lavoro mt 2,49



CONFORMAZIONE DI SERIE

- Base cm.85 x 154
- Struttura cm.76 x 154
- 2 piani di lavoro: cm.30 x 155



TRABATTELLO MITO



Cod. art. **6198**

ACCESSORI NON INCLUSI

Livellatore a vite

Cod.6199

Dettaglio

Dettaglio

In dotazione



Livellatore a vite
Non incluso



Innesti rastremati
Maschio/femmina



Facile passaggio
tra le porte



Piano di lavoro

Composizione Trabattello MITO

Portata max per piano di lavoro kg.120 Peso totale della torre Kg.63	Codice Articolo 6198	Componenti in dotazione
1	Pz.4	Stabilizzatori
2	Pz.2	Testata con ruote \varnothing 125
3	Pz.2	Ringhiera di protezione
4	Pz.2	Spalla mm.200
5	Pz.2	Spalla mm.100
6	Pz.2	Maniglioni terminali
7	Pz.4	Traversa con 4 saette

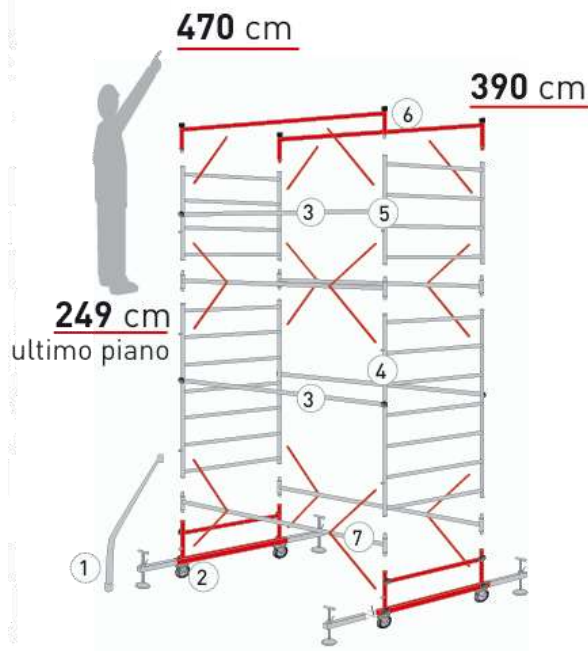

Smalti & finiture

- Smalti sintetici
- Smalti all'acqua
- Fondi sintetici
- Fondi all'acqua
- Primer
- Marker Paint

CAPEC
WORK PROJECT



BORMA WACHS®
Wood Professional Cosmetics



DILACK – smalto sintetico extra

Smalto sintetico uretanico per finiture interne ed esterne. Possiede ottima resistenza all'ambiente esterno. In fase di applicazione, garantisce ottima distensione ed elevato potere coprente. Si applica su qualsiasi manufatto in legno e ferro, previa preparazione del supporto.



Codice	ml.375	Codice	ml.750	Codice	Lt.2,5
23330	Bianco L.	23360	Bianco L.	23390	Bianco L.
23331	Bianco O.	23361	Bianco O.	23391	Bianco O.
23332	Nero L.	23362	Nero L.	23392	Nero L.
23333	Nero O.	23363	Nero O.	23393	Nero O.
23340	Rosso Cina	23370	Rosso Cina	23395	Rosso Cina
23343	Verde M.	23373	Verde M.	23394	Verde M.
23334	Bianco P.	23364	Bianco P.		
23335	Avorio C.	23365	Avorio C.		
23336	Grigio Arg.	23366	Grigio Arg.		
23337	Grigio Ard.	23367	Grigio Ard.		
23338	Grigio Ch.	23368	Grigio L.		
23339	Giallo Oro	23369	Giallo Oro		
23341	Blu Seg.	23371	Blu Seg.		
23342	Verde Sm.	23372	Verde Sm.		
23344	Giallo Afr.	23374	Giallo Afr.		
23345	Camoscio	23375	Camoscio		
23346	Marrone C.	23376	Marrone C.		
23347	Arancio P.	23377	Arancio P.		
23348	Azzurro O.	23378	Azzurro O.		



Smalti & Finiture

Bianco lucido	Nero lucido	Bianco opaco	Nero opaco
Bianco perla Ral 1013	Avorio chiaro 1515	Giallo oro 3207	Rosso cina 5409
Grigio chiaro 6600	Grigio argento 6616	Grigio ardesia 6606	Arancio puro Ral 2004
Azzurro olimpico 8813	Blu segnale Ral 5017	Verde smeraldo 7707	Verde muschio 6005
Giallo africa 3217	Camoscio 4308	Marrone cioccolato Ral 8017	

MINI DILACK – smalto sintetico extra

Smalto sintetico uretanico per finiture interne ed esterne. Possiede ottima resistenza all'ambiente esterno. In fase di applicazione, garantisce ottima distensione ed elevato potere coprente. Si applica su qualsiasi manufatto in legno e ferro, previa preparazione del supporto.



Codice	ml.100	Codice	ml.100
23300	Bianco Lucido	23310	Rosso Cina
23301	Bianco Opaco	23311	Blu Segnale
23302	Nero Lucido	23312	Verde giallo
23303	Nero Opaco	23313	Verde Muschio
23305	Avorio Chiaro	23315	Camoscio
23306	Grigio Argento	23316	Marrone Cioccolato
23307	Grigio Ardesia	23317	Oro moderno
23308	Grigio Chiaro	23319	Argento
23309	Giallo Oro		



Smalti & Finiture



FONDO PRIMER - ZINCOSYNT

Fondo sintetico. Viene utilizzato per la protezione temporanea di manufatti in ferro e come prima mano ancorante su lamiera zincata.



Cod. art. 07400 07401

Formato ml.500 Litri 2,5



ANTIRUGGINE - SYNTAX

E' indicata per la protezione temporanea di manufatti in ferro e per lavori di carpenteria. Sovra verniciabile solo con smalti sintetici.



Cod. art. 0777G 0778G 0777R 0778R

Formato ml.500 Lt. 2,5
grigia grigia rossa rossa



ANTIRUGGINE NITRO - DYRUST

Antiruggine Grigia a base di resine oleofenoliche e fosfato di zinco. Di rapida essiccazione è sovra verniciabile con smalti nitro.



Cod. art. 0776G

Formato Litri 2,5



CEMENTITE - FONDOLACK

Pittura sintetica opaca riempitiva. E' indicata come mano di fondo su legno o come finitura opaca su intonaco.



Cod. art. 0823 0822

Formato ml.500 Litri 2,5



VERNICE PER SEGNALETICA

Pittura per segnaletica stradale orizzontale. Caratterizzata da rapida essiccazione, buona aderenza ed elasticità.



Cod. art. 0775 B 0775 G

Formato Lt.4 Bianca Lt.4 Gialla



SMALTO RAPIDA ESSICCAZIONE

Smalto antiruggine a rapida essiccazione, utilizzabile come fondo-finitura. Ideale per applicazioni su manufatti in ferro o legno, da esterno.



ml.750	ml.750 Ral 9005	ml.750 Ral 9005	ml.750 Ral 1028	ml.750 Ral 3004
Bianco lucido 23400	Nero lucido 23401	Nero Opaco 23404	Giallo opaco 23402	Rosso opaco 23403
Lt.2,5	Lt.2,5 Ral 9005	Lt.2,5 Ral 9005	Lt.2,5 Ral 1028	Lt.2,5 Ral 3004
Bianco lucido 23410	Nero lucido 23411	Nero Opaco 23414	Giallo opaco 23412	Rosso opaco 23413

CONVERTER – BASE NEUTRA

Cod. art.	23409	23419
Formato	ml.600	Litri 2



SMALTO MICACEO ALTA COPERTURA

Lo Smalto Ferro-Micaceo è un prodotto pronto all'uso, di facile applicazione, speciale per metallo, in ambiente interno ed esterno, con eccezionali proprietà anticorrosive e decorative.

Grazie alla speciale formulazione con ossidi di ferro micaceo a grana medio-fine.

ml.750	ml.750	ml.750	ml.750	ml.750	ml.750
Grigio S. 078060	Grigio M. 078061	Grigio C. 078062	Rame 078063	Marrone 078064	Verde 078065
Lt.2,5	Lt.2,5	Lt.2,5			
Grigio S. 078070	Grigio M. 078071	Grigio C. 078072			



SMALTO PER ALTE TEMPERATURE

Lo Smalto per alte temperature è un protettivo a base alchidico-siliconica, speciale per superfici e strutture in metallo o cemento sottoposte a calore intenso.

Resiste a temperature fino a 800°C non continuative.



ml.125	ml.125	ml.375	ml.375	ml.750	ml.750
Alluminio 1265.37	Nero 1265.36	Alluminio 07734	Nero 07733	Alluminio 07732	Nero 07731



SMALTO ANTIRUGGINE ALTA COPERTURA 3 in 1

Smalto ad alta copertura pronto all'uso, di facile applicazione, adatto ad ogni tipo di supporto, in ambiente interno ed esterno. E' consigliato per la finitura o la manutenzione di superfici in legno, ferro, muratura.

[Mano diretta su lamiera zincata](#)

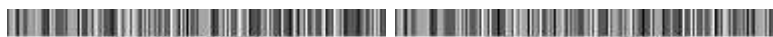

Codice	ml.750	Codice	Lt.2,5
07710	Bianco Lucido	07700	Bianco Lucido
07730	Bianco Opaco	07701	Bianco Opaco
07711	Nero Lucido	07705	Nero Lucido
07723	Nero Opaco		
07718	Bianco Perla		
077181	Bianco grigio		
07727	Avorio Chiaro	07703	Marrone C.
07714	Grigio Argento		
07715	Grigio Antracite	07702	Grigio Antracite
07725	Grigio Luce	07707	Grigio Luce
07720	Grigio Ferro	07706	Grigio Ferro
07722	Grigio Pietra		
07712	Marrone Cioccolato	07703	Marrone C.
07713	Marrone Segnale		
077131	Marrone Noce		
07721	Marrone Nerastro		
07716	Verde Muschio	07704	Verde Muschio
07717	Verde Foglia		
077171	Verde pino		
07719	Rosso Segnale		
07724	Blu Traffico		
07726	Giallo Navone		



BORMA COLOR
Smalto alta
copertura 3in1
Fondo finitura legno-metallo
e lamiera zincata



Per la finitura o la manutenzione di superfici in legno, ferro e muratura, conferisce un effetto di notevole copertura e riempimento.



CONVERTER 3IN1 – BASE NEUTRA

Cod. art.	07728	07729	07709	07708
Formato	ml.600 Lucido	ml.600 Opaco	Lt.2 Lucido	Lt.2 Opaco



Bianco lucido 50	Nero lucido 9005	Bianco opaco 50	Nero opaco 9005	Bianco grigio Ral 9002
Bianco perla Ral 1013	Avorio chiaro Ral 1015	Giallo navone Ral 1021	Rosso segnale Ral 3001	Blu traffico Ral 5017
Grigio luce Ral 7035	Grigio pietra Ral 7030	Grigio argento Ral 7001	Grigio ferro Ral 7011	Grigio antracite Ral 7016
Marrone noce Ral 8011	Marrone segnale Ral 8002	Marrone cioccolato Ral 8017	Marrone nerastro Ral 8022	
Verde foglia Ral 6002	Verde pino Ral 6028	Verde muschio Ral 6005		

SMALTO PER SANITARI

Ideale per rinnovare la superficie di vasche da bagno e sanitari in generale. Consente di rinnovare in sole due mani superfici corrose e rovinate. Disponibile in bianco lucido.



SMALTO PER SANITARI

Cod. art.	formato	
07415	ml.500 + ml.250 catalizzatore	



SOTTOSMALTO ANTIRUGGINE

Il Sottosmalto Antiruggine sintetico è un prodotto pronto all'uso, di facile applicazione consigliato per ferro, in ambiente interno ed esterno. Di elevata densità, è consigliato come primer per superfici in ferro, nuove o da restaurare. **Colore BIANCA**



SOTTOSMALTO ANTIRUGGINE

Cod. art.	0777 B	0778 B
Formato	ml.375	Lt.2,5



SOTTOSMALTO ANCORANTE

Fondo aggrappante speciale per lamiera zincate, metalli difficili in genere (ghisa, rame, ottone, acciaio) e materie plastiche come il pvc. Consente la sovrapplicazione di qualsiasi tipo di smalto.



SOTTOSMALTO ANCORANTE

Cod. art.	07402	07403
Formato	ml.375	ml.750



ZINCANTE A FREDDO

Protettivo speciale a pennello, monocomponente, ideale per la protezione delle superfici in metallo sia da interno che da esterno. Garantisce una superiore resistenza alla corrosione dovuta ad agenti esterni.



ZINCANTE A FREDDO

Cod. art.	0933
Formato	ml.375



OXY STOP

FINITURA TRASPARENTE

E' una finitura acrilica, atossica indicata per la protezione di superfici metalliche nuove o precedentemente trattate. Protegge le parti trattate rendendole impermeabili ed efficacemente schermate contro l'azione dannosa dei raggi UV.



OXY STOP



Cod. art. 10395

Formato ml.375



PLASTIVEL PLASTIFICANTE

Il film che si realizza con PLASTIVEL su tutti i materiali, è incolore, trasparente e lucido. La sua brillantezza (Gardner a 60°C) da 84 a 92 gloss a seconda dello spessore del film. (15-20 micron)
Resistenza ai raggi ultravioletti e al calore.



PLASTIVEL



Cod. art. 0708 0709 0710 0711

Formato ml.400 spray ml.500 lt.1 lt. 2,5



ANTIROMBO BITUMINOSO

Usato in carrozzeria come insonorizzante protettivo per cisterne e tubazioni da interrare.



ANTIROMBO BITUMINOSO



Cod. art. 1360 1361

Formato ml.750 Lt.4



CATRAMINA BITUMINOSA

Protettivo per strutture metalliche, grondaie, serbatoi.
Diluito può essere utilizzato come sottofondo per guaine



CATRAMINA BITUMINOSA



Cod. art. 1380 1381

Formato ml.750 Lt.5



GENESIS – SMALTO MULTISUPERFICIE

Grazie alla nuova formulazione aderisce a ogni superficie e offre elevate prestazioni in termini di resistenza chimica e meccanica è antimacchia, non ingiallente, idrorepellente, antigraffio, calpestabile.

Nella fase di preparazione della superficie non necessita di applicazione dei fondi particolari.

Per aumentare l'adesione si consiglia l'uso del PROAQUA ADDITIVE BORMA PRO nel rapporto 1:10



GENESIS SMALTO MULTISUPERFICIE

Codice	ml.750	Codice	Lt.2,5
07302	Bianco satinato	07322	Bianco satinato
07300	Bianco Opaco	07320	Bianco Opaco
07306	Nero		
07304	Rosso Borgogna	07313	Proaqua XA9124
07305	Ottanio		
07307	Grigio Antracite		
07308	Grigio Argento		
07309	Verde Pastello		
07310	Beige Sabbia		
07311	Avorio Chiaro		
07312	Bianco Perla		
07315	Trasparente Lucido		



Smalti & Finiture



Bianco satinato
50 gloss

Bianco opaco
10 gloss

Trasparente lucido
80 gloss

Nero
25 gloss



Bianco perla
Ral 1013 – 25 gloss

Avorio chiaro
Ral 1015 – 25 gloss

Beige sabbia 280
25 gloss

Verde pastello 287
25 gloss



Rosso borgogna 290
25 gloss

Ottanio 291
25 gloss

Grigio antracite 7016
25 gloss

Grigio argento 7001
25 gloss

SMALTO ALTA COPERTURA

Smalto all'acqua pronto all'uso, ecologico ed inodore, di facile applicazione, adatto ad ogni tipo di supporto, in ambiente interno ed esterno. Di elevata densità, è consigliato per la finitura o la manutenzione di superfici in legno, ferro, muratura etc.

Smalti & Finiture



Codice	ml.125	Codice	ml.375	Codice	ml.750	Codice	Lt.2,5
12812	Bianco L.	12780	Bianco L.	12790	Bianco L.	127901	Bianco L.
12813	Bianco O.	12781	Bianco O.				
12814	Nero L.	12782	Nero L.	12792	Nero L.		
12815	Nero O.	12783	Nero O.	12793	Nero O.		
12825	Bianco P.	127891	Bianco P.	127991	Bianco P.		
12826	Bianco G.	127892	Bianco G.	127992	Bianco G.		
12818	Avorio C.	127893	Avorio C.	127993	Avorio C.		
12827	Grigio Arg.	127896	Grigio Arg.	127996	Grigio Arg.		
12809	Grigio V.	127895	Grigio Luce	127995	Grigio Luce		
12828	Grigio F.	12788	Grigio F.	12798	Grigio F.		
12819	Rosso F.	12787	Rosso F.	12797	Rosso F.		
12802	Giallo N.	12786	Giallo N.	12796	Giallo N.		
12821	Blu T.	12789	Blu T.	12799	Blu T.		
12808	Verde M.	12785	Verde M.	12795	Verde M.		
12824	Verde F.	127894	Verde F.	127994	Verde F.		
12829	Marrone S.	127897	Marrone S.	127997	Marrone S.		
12810	Marrone N.	12784	Marrone N.	12794	Marrone N.		
12811	Marrone C.	127898	Marrone C.	127998	Marrone C.		



Smalto alta copertura 3in1 universale all'acqua

Decorativo, idrorepellente e resistente agli agenti atmosferici. A basso inquinamento. Scartevole ed elastico. È caratterizzato da un'elevata opacità e non scolorisce.



Bianco lucido 50	Nero lucido 9005	Bianco opaco 50	Nero opaco 9005	Bianco grigio Ral 9002
Bianco perla Ral 1013	Avorio chiaro Ral 1015	Giallo navone Ral 1021	Rosso fuoco Ral 3000	Blu traffico Ral 5017
Grigio luce Ral 7035	Grigio argento Ral 7001	Grigio vaio Ral 7000	Grigio ferro Ral 7011	
Marrone noce Ral 8011	Marrone segnale Ral 8002	Marrone cioccolato Ral 8017		
Verde foglia Ral 6002	Verde muschio Ral 6005			



NATURAQUA WHITE BIANCO

Adatto ad ogni tipo di supporto, in ambiente interno ed esterno a basso VOC. Crea un film decorativo, idrorepellente e resistente agli agenti atmosferici, a basso ingiallimento. [Bianco opaco 20 gloss SUPER COPRENTE](#)



Cod. art.	12791	127911
formato	ml.750	Lt.2,5



SMALTO PER TERMOSIFONI

Con funzione di fondo- finitura antiruggine all'acqua è adatto a superfici sottoposte a calore, è inodore e di rapida essiccazione. [Colore Bianco](#)



Cod. art.	078109	078110	078112	078113
Formato	ml.375 Lucido	ml.750 Lucido	ml.375 Opaco	ml.750 Opaco



SOTTOSMALTO AD ACQUA

Fondo/Cementite pronto all'uso, inodore ed ecologico, di facile applicazione, consigliato per legno, per interno ed esterno.



Cod. art.	078100	078101
Formato	ml.375	ml.750



SOTTOSMALTO ANTIRUGGINE AD ACQUA

Fondo all'acqua con funzione anticorrosiva, inodore e a rapida essiccazione, speciale per metalli ferrosi. [Colore bianco](#)



Cod. art.	078103	078104
Formato	ml.375	ml.750



RICOLORA - tinte pastello

Colori acrilici all'acqua pronti all'uso. Tinte coprenti, versatili, brillanti e perfettamente miscelabili tra loro.

Codice 1900 Vasetto da 150 ml.

Codice 1910.01 Barattolo da lt.1 Bianco



1910.01 BIANCO lt.1



1900.01 BIANCO



1900.02 PANNA



1900.03 AVORIO



1900.05 CARNICINO



1900.06 SABBIA



1900.10 VERDE G.



1900.12 GIALLO P.



1900.13 GIALLO C.



1900.14 ARANCIO



1900.15 ROSSO



1900.16 CARMINIO



1900.17 MAGENTA



1900.18 BORDEAUX



1900.19 OCRA



1900.20 TERRA DI S.



1900.21 TERRA B.



1900.23 MARRONE



1900.24 OCRA ROSSA

RICOLORA - tinte pastello



RICOLORA TINTE PASTELLO



1900.25 BLU P.



1900.27 AZZURRO



1900.28 VERDE O.



1900.29 VERDE P.



1900.30 VERDE M.



1900.31 NERO



1900.41 LILLA



1900.42 VIOLA

RICOLORA - tinte metallizzate



RICOLORA TINTE METALLIZZATE



ORO 32



ORO RICCO 33



ORO DUCATO 34



BRONZO 36



RAME 37



ARGENTO 39



PERLATO 40



1905 FONDO GESSO



1905

Smalti & Finiture

Cod. art.	Formato	colore	colore	colore	colore	colore	colore	colore
1900	ml.150	Oro 32	Oro ricco 33	Oro ducato 34	Bronzo 36	Rame 37	Argento 39	Perlato 40
1910	Lt.1	Oro 32	Oro ricco 33	Oro ducato 34	Bronzo 36		Argento 39	Perlato 40
1920	Kg.3	Oro 32						Perlato 40

SMALTO AD ACQUA RIVER

Smalto all'acqua, Inodore e a basso impatto ambientale.
Facile da applicare a pennello o a spruzzo senza colature.
Lavabile con detergenti neutri in soluzione acquosa.
Ideale per mobili e manufatti in legno.
Ottimo per la verniciatura dei termosifoni.



Cod. art.	07440	07441
Lucido	ml.750	Lt.2,5
Cod. art.	07442	07443
Opaco	ml.750	Lt.2,5



FONDO AD ACQUA RIVER

Fondo tixotropico per legno e muratura.
Non cola, non gocciola, ha forte potere riempitivo ed è perfettamente lavabile. Non essendo assorbente costituisce un sottofondo ideale su cui gli smalti di finitura possono essere applicati senza che si determinano cali di brillantezza.



Cod. art.	07420	07421
Formato	ml.750	Lt.2,5



SMALTO MURALE ANTIGRAGGIO

Pittura ad effetto lavagna, ideale per trasformare qualsiasi supporto in una lavagna riscrivibile con gessetti colorati.
Adatta per decorare ambienti ricreativi o didattici, locali pubblici (ristoranti, negozi, showroom, etc..)



Cod. art.	83242
Formato	ml.750



Risanamento murale

- Traspiranti
- Lavabili
- Quarzi
- Primer - isolanti
- Smalti murali
- Idrorepellenti siliconici
- Bonifica della muffa
- Coloranti universali

ORIGINAL
decotric[®]

Lympha
professional

CAPEC
WORK PROJECT

linea **STOP**
DIXI
DIVISIONE CHIMICA

CASATI



SMALTO MURALE - **ZAHIR**

SMALTO MURALE ZAHIR

Formulato per uso professionale inodore, non ingiallente, con contiene solventi, ad effetto lucido o opaco. Antigraffio, resistente al lavaggio ed è smacchiabile con facilità. Elevata copertura a basso spessore.

Per muratura, cartongesso e termosifoni in ambienti interni (ospedali, cliniche, scuole, asili, uffici ecc.)

Cod. art.	0811	0810	Cod. art.	0809	0808
Finitura Satinata	Lt.5	Lt.10	Finitura Lucida	Lt.5	Lt.10

PITTURA SUPERLAVABILE - **ALTEA**

SUPERLAVABILE ALTEA

Formulata per uso professionale con elevata capacità di soddisfare anche applicatori esigenti. Grazie alla particolare granulometria e all'alta opacità, uniforma il supporto, mascherando eventuali piccole imperfezioni. Ottimo potere coprente e riempitivo, eccellente punto di bianco, resistente all'abrasione a secco, ottima distensione e pennellabilità.

Ideale per superfici murali in intonaco civile, gesso, cartongesso, di edilizia abitativa, locali ed uffici industriali di uso interno.

Cod. art.	0782	0783	0784	0786
Formato	ml.750	Lt.2,5	Lt.5	Lt.14

PITTURA LAVABILE - **OLEA**

LAVABILE OLEA

Prodotto professionale per applicazioni murarie all'interno, dotata di ottima copertura, facile da applicare e con aspetto finale di un ottimo opaco, non screpola e non sfoglia. Ottimo potere riempitivo, buon punto di bianco, ottimo ancoraggio al supporto, buona resistenza all'abrasione a secco, assenza di gocciolamento.

Cod. art.	0787	0788	0789
Formato	Lt.2,5	Lt.5	Lt.13



IDROPITTURA SUPERTRASPIRANTE - LAURUS



Pittura formulata per garantire buoni risultati di permeabilità al vapore acqueo e permette un'eccellente traspirazione dei muri. Contemporaneamente possiede buone doti di idrorepellenza, elevata copertura, facile pennellabilità, ottima stesura. Ideale per ogni ambiente soggetto a formazione di condensa, in particolare bagni, cucine e cantine. Offre adesione e traspirabilità, ed impedisce il formarsi di muffe. Applicare su soffitti e muri in gesso, stucco, cemento e intonaco soggetti a vapori acquei.



Cod. art.	0791	0792
Formato	Lt.4	Lt.13



IDROPITTURA TRASPIRANTE - BRIZA



Pittura formulata per garantire buone doti di permeabilità al vapore acqueo e permette un'ottima traspirazione dei muri. Contemporaneamente possiede buone doti di idrorepellenza, elevata copertura, facile pennellabilità, ottima dilatazione, particolarmente riempitiva per nascondere piccoli difetti e irregolarità della superficie trattata grazie alla sua robustezza. Per la finitura di pareti e soffitti all'interno. Indicata per gli ambienti umidi, tipo bagni e cucine.



Cod. art.	0793	0794	0795
Formato	Lt.2,5	Lt.5	Lt.13



IDROPITTURA IGIENIZZANTE ANTIMUFFA - IRIS PLUS



Formulata per la risoluzione di quei problemi legati alla comparsa di batteri e muffe di diverso genere sulle pareti con forte concentrazione di vapore acqueo. Apprezzabili caratteristiche di questo prodotto sono la notevole copertura, finitura gradevole al tatto, ottimo punto di bianco traspirabilità. Conforme alla norma UNI EN 15457 (resistenza alla crescita di funghi).



Cod. art.	0826	0825	0824
Formato	ml.750	Lt.5	Lt.12



PITTURA TERMOISOLANTE ANTIMUFFA - **THERMO**



Thermo è la risposta più efficace al problema delle muffe da condensa su pareti. Grazie alla presenza di microsferine cave, il prodotto sviluppa calore sulle superfici delle pareti, diminuendo la conducibilità termica sulle stesse, consentendo così di arginare il problema dei punti freddi, evitando quindi la formazione di condense e muffe.



Cod. art.	0827	0828	0829
Formato	ml.750	Lt.5	Lt.12



PITTURA ELASTOMERICA AL QUARZO - **KALOS**



Idropittura a base di biossido di titanio, polimeri elastomerici in dispersione acquosa, pigmenti resistenti alla luce e agli agenti atmosferici, particolari additivi. Essendo dei rivestimenti molto coprenti e di spessore nettamente superiore agli altri rivestimenti della facciata, le pitture elastomeriche hanno un particolare effetto coprente in grado di mascherare completamente il supporto.



Cod. art.	0796	0797
Formato	Lt.5	Lt.14



PITTURA AL QUARZO - **KALIKA**



Idropittura di emulsioni stiroacriliche all'acqua, pigmenti inorganici, farine di quarzo resistente all'esposizione all'esterno. Dotata di buona lavabilità, facilità di applicazione, resistenza allo sfregamento e all'aggressione degli agenti atmosferici ed inquinanti.



Cod. art.	0798	0799
Formato	Lt.5	Lt.14

FISSATIVO ISOLANTE ACRILICO

Migliora l'adesione e l'applicazione delle pitture.
Indicato per uso interno/esterno.
A base di resine acriliche.
Diluibile in 6 litri di acqua.
Colore trasparente



FISSATIVO ISOLANTE ACRILICO

Cod. art. 0800 0802

Formato Lt.1 Lt.5



POWER PRIMER PP

- ✓ Fondo concentrato a base d'acqua.
- ✓ Per il consolidamento di supporti porosi.
- ✓ Indicato per uso interno/esterno.
- ✓ Diluibile da 1:4 a 1:7, a seconda del sottofondo.
- ✓ Colore trasparente



POWER PRIMER PP

Cod. art. 0807

Formato Lt.1



Risanamento Murale

NO MUFFA FISSATIVO ISOLANTE

- ✓ Primer igienizzante in emulsione acquosa, ad azione antimuffa.
- ✓ E' indicato per supporti interni.
- ✓ Grazie a l'elevato potere ancorante migliora l'adesione e l'applicazione delle pitture.
- ✓ Consolida il supporto in profondità garantendo una maggiore durata nel tempo.



NO MUFFA FISSATIVO ISOLANTE

Cod. art. 0803

Formato Lt.1



WILKALOR FISSATIVO TERMICO

E' una resina acrilica in emulsione con microsfere di vetro.
E' un rivoluzionario prodotto per l'isolamento termico, particolarmente indicato per l'applicazione su muri freddi e umidi.
L'uso di Wilkolor consente un recupero termico di almeno 2/3°C.
Grazie alle sue caratteristiche è adatto per l'utilizzo in ogni situazione in cui abbiamo necessità di conservare calore o impedire l'ingresso del freddo.



WILKALOR FISSATIVO TERMICO

Cod. art. 10398

Formato Litri 1



UKIN ISOLANTE NEUTRALIZZANTE

E' un sale idrosolubile a base di composti d'alluminio e silicati usato per il trattamento dei fondi murali prima della loro verniciatura.
E' imbattibile nel trattamento delle macchie di fumo e acqua ferma, che elimina con facilità e a costi molto ridotti.
Neutralizza: macchie vecchie di acqua, fumo, nicotina, fuliggine.

Diluizione: vedi scheda tecnica



UKIN ISOLANTE NEUTRALIZZANTE

Cod. art. 0602

Formato Kg. 1



PELLICOLA ISOLANTE IN ALLUMINIO

- ✓ Carta foglio di alluminio spessore 0,008 mm laminata su un lato
- ✓ Valore SD = 440 m di spessore equivalente dello strato d'aria
- ✓ Applicazione con colla Profieinsetkleber cod.1184



PELLICOLA ISOLANTE IN ALLUMINIO

Cod. art. 4457

Formato cm.50 x 10 mt

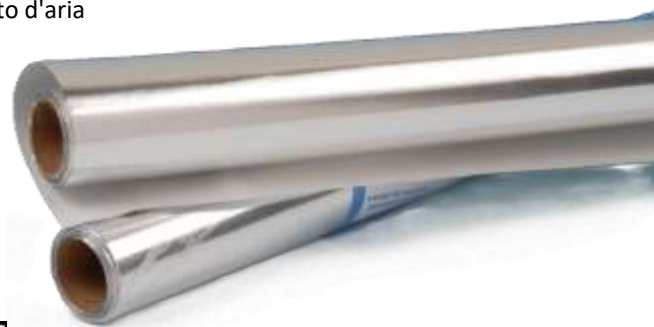

IL MUFFA STOP

- ✓ Elimina in pochi minuti qualsiasi traccia di muffe, alghe e muschi, presenti in qualsiasi tipo di ambiente.
- ✓ E' un prodotto pronto all'uso.



IL MUFFA STOP



Cod. art.	10390	10391	10392
Formato	ml.250	ml.500	ml.1000



SHIMMEL ANTIMUFFA

- ✓ Per eliminare a fondo, rapidamente e visibilmente ogni traccia di muffa, alghe e batteri.
- ✓ Adatto per tutti i fondi minerali come intonaco calcestrutto, piastrelle di ceramica, mattoni.



SHIMMEL ANTIMUFFA



Cod. art.	1037	1038
Formato	ml.250	ml.500



ALGEN & SHIMMEL STOP

- ✓ Svolge un'azione autopulente e rimuove ogni traccia di muffa e alghe anche negli ambienti interni senza sprigionare cattivi odori.
- ✓ Indicato anche come trattamento preliminare di facciate.

Esente da cloro



ALGEN & SHIMMEL STOP



Cod. art.	1036
Formato	ml.500



ANTIMUFFA CONCENTRATO

- ✓ Additivo per vernici fungicida. Soluzione concentrata con effetto a lungo termine contro muffe e alghe.

Come additivo: diluizione 250 ml. In 10/14 litri di pittura

Come risanante : diluizione in 8 litri di acqua

Ad uso interno ed esterno



ANTIMUFFA CONCENTRATO



Cod. art.	1022
Formato	ml.250



AQUA DECK ISOLIERFARBE 2IN1

PITTURA ISOLANTE BIANCA

isola le macchie di nicotina fuliggine, grasso e acqua, copre gli ingiallimenti.



AQUA DECK ISOLIERFARBE 2IN1

Cod. art.	08071	08072	08073
Formato	ml.750	Lt.5	Lt.10



SCHNELL RENOVIERFARBE

VERNICE ANTIFUMO

Isola in modo affidabile nicotina, acqua, fuliggine e macchie di grasso su tutte le superfici minerali.



SCHNELL RENOVIERFARBE

Cod. art.	08070
Formato	Lt.10



ISOLIERFARBE FEUCHTBLOCKER

VERNICE ISOLANTE

Neutralizza macchie d'acqua, di nicotina e di fuliggine. Impedisce la formazione di efflorescenze su tutti i supporti minerali quali calcestruzzo, intonaci a base di calce e cemento, mattoni, ecc.



ISOLIERFARBE FEUCHTBLOCKER

Cod. art.	06060	06061
Formato	ml.750	Lt.2



FLECKEN DECKER ISOLIERWEIB

SPRAY ISOLANTE BIANCO

Per bloccare macchie di nicotina, acqua e fuliggine, scarabocchi e altre contaminazioni solubili in acqua all'interno e all'esterno.



FLECKEN DECKER ISOLIERWEIB

Cod. art.	1250
Formato	ml.400



TINTACAPEC – colorante universale

Nero LW71 0687N	Verde ossido LW61 0687VOS
Verde vivo LW62 0687VB	Terra LW53 0687T
Marrone LW51 0687TB	Violetto LW81 0687VI
Blu LW21 0687BL	Bianco LW01 0687BI
Arancio L36 0687AR	Arancio ossido LW14 0687AO
Rosso segnale L32 0687RS	Rosso ossido LW31 0687RO
Giallo canarino L12 0687GC	Giallo limone L13 0687GL
Giallo mais L15 0687GM	Giallo ossido LW11 0687GO

Flacone da ml.50



Cod. art. **0688.35**
Espositore 108 pezzi



Cod. art. **0691**
Cartella colori

Nero LW71 0686N	Verde ossido LW61 0686VOS
Verde vivo LW62 0686VB	Terra LW53 0686T
Marrone LW51 0686TB	Violetto LW81 0686VI
Blu LW21 0686BL	Bianco LW01 0686BI
Arancio L36 0686AR	Arancio ossido LW14 0686AO
Rosso segnale L32 0686RS	Rosso ossido LW31 0686RO
Giallo canarino L12 0686GC	Giallo limone L13 0686GL
Giallo mais L15 0686GM	Giallo ossido LW11 0686GO

Flacone da ml.25



TINTACAPEC COLORANTE 50



TINTACAPEC COLORANTE 25

Nero T24 03224	Verde tenero T31 03231
Verde intenso T32 03232	Terracotta T22 03222
Marrone T23 03223	Violetto T29 03229
Blu T30 03230	Rosso T28 03228
Arancio T27 03227	Bianco T00 03220
Giallo oro T25 03225	Giallo limone T26 03226
Giallo sole T34 03234	Ocra T21 03221

Flacone da ml.50

Totocolor



Nero T24 03124	Verde tenero T31 03131
Verde intenso T32 03132	Terracotta T22 03122
Marrone T23 03123	Violetto T29 03129
Blu T30 03130	Rosso T28 03128
Arancio T27 03127	Giallo oro T25 03125
Giallo sole T34 03134	Giallo limone T26 03126
	Ocra T21 03121

Flacone da ml.15



TOTOCOLOR COLORANTE 50



TOTOCOLOR COLORANTE 15

**LIANTONIO
VERNICI**

Risanamento Murale

TINTAMANO

colorante universale

SUPERTINTASOL

colorante universale
superconcentrato

Nero LW71 0693N	Verde ossido LW61 0693VO
Verde vivo LW62 0693VB	Terra LW53 0693T
Marrone LW51 0693TB	Violetto LW81 0693VI
Blu LW21 0693B	Rosso ossido LW31 0693RO
Arancio L36 0693A	Rosso segnale L32 0693RS
Giallo canarino L12 0693GC	Giallo limone L13 0693GL
Giallo mais L15 0693GM	Giallo ossido LW11 0693GO

Nero LW71 03303	Blu LW21 03306
Marrone LW51 03301	Rosso ossido LW31 03307
Giallo ossido LW11 03307	Giallo canarino L12 03304

Flacone da ml.250

Flacone da ml.250



Risanamento Murale



Cod. art.

8216

8231

8236

8226

8221

8211

Colori

Rosso

Verde
cemento

Blu
oltremare

Marrone
ossido

Nero

Giallo
fiore



Cod. art.

8266

8261

8276

Colori

Rosso
Inglese

Ocra gialla

Terra ombra

Risanamento Terrazze – pavimenti - Muri

- Guaine liquide
- Impermeabilizzanti
- Cere
- Detergenti

Glutoclean

Akfix
MASTER OF SOLUTIONS

CAPEC
WORK PROJECT



BORMA WACHS
Wood Professional Cosmetics



GUAINA LIQUIDA IMPERMEABILIZZANTE

Calpestabile al 70% elastica, monocomponente a base di polimeri.
Per tetti, terrazze, tettoie, grondaie, lamiere zincate
Resa: ca. 0,8 – 1,5 kg./mq



Cod. art.	0745 G	0746 G	0747 G
-----------	--------	--------	--------

GRIGIA	Kg.1	Kg.5	Kg.20
--------	------	------	-------

Cod. art.	0745 B	0746 B	0747 B
-----------	--------	--------	--------

BIANCA	Kg.1	Kg.5	Kg.20
--------	------	------	-------



AQUAZERO AKFIX

Impermeabilizzante elastico di prima qualità a base di polimeri.
Per tetti, terrazze, tettoie, grondaie, lamiere zincate

COLORE GRIGIO



Cod. art.	Formato
-----------	---------

0748 G	Kg.14
--------	-------



PROTEGGI TERRAZZE CAPEC

E' una soluzione a base acqua in grado di penetrare nei materiali porosi e formare una barriera invisibile idrorepellente.
Calpestabile. Colore trasparente



Cod. art.	1770	1771
-----------	------	------

Formato	Lt.1	Lt.5
---------	------	------



WALL PROTECT FINISH

FINITURA PROTETTIVA PER PARATI E MURI

Satinata PU a base d'acqua per uso interno/esterno.
Adatta per carta da parati, pitture a emulsione, piastrelle e legno.
Ideale per materiale plastico. Resistente agli schizzi e ai detergenti



Cod. art.	Formato
-----------	---------

06063	ml.750
-------	--------



MAIOLICATO CAPEC

E' una soluzione a base acqua in grado di penetrare nei materiali porosi e formare una barriera invisibile idrorepellente. Calpestable. Colore trasparente



MAIOLICATO CAPEC

Cod. art. 0806 0804

Formato Lt.1 Lt.5



HIDRO - IDROREPELENTE

Per materiali lapidei porosi, pietre naturali, tufi, mattoni, coppi ecc. Il principio attivo siliconico penetra facilmente nelle porosità e si dispone sulla superficie dei pori senza occluderli legandosi alla parte silicatica del supporto.



HIDRO IDROREPELENTE

Cod. art. 1783 1784

Formato Lt.1 Lt.5



SALPETER ENTFERNER

Antisalinetro. Rimuove senza fatica le efflorescenze su finiture, calcestruzzo, mattoni, clinker, pietra naturale e altre superfici resistenti agli acidi. Pronto per l'uso.



SALPETER ENTFERNER

Cod. art. Formato

06064 Lt.1



FASSADEN IMPRAGNIERUNG

IMPREGNANTE SILOSSANICO PER PIETRA E MARMO

Senza solventi per superfici minerali. Protegge dall'umidità e dalla pioggia battente grazie all'idrorepellenza. Impedisce l'assorbimento di umidità e acqua senza solventi, a base d'acqua. Incolore, trasparente



FASSADEN IMPRAGNIERUNG

Cod. art. Formato

06065 Lt.1



MARMOR UND GRANIT IMPRAGNIERUNG

IMPERMEABILIZZANTE PER MARMO

Pronto all'uso per la protezione duratura da macchie di olio, grasso, calcare e acqua. Impedisce l'infiltrazione di sporco, umidità, vernici, olio e grasso e facilita la pulizia.



Cod. art. formato

1421 Lt.1



FEINSTEINZEUG IMPRAGNIERUNG

IMPERMEABILIZZANTE PER GRES

Impermeabilizza le superfici in modo duraturo e assicura una protezione invisibile contro lo sporco e le tracce d'usura. In ambienti interni ed esterni.



Cod. art. Formato

1422 Lt.1



STEIN VERSIEGELUNG

IMPERMEABILIZZANTE PER PIETRA

Sigillatura con protezione duratura della pietra. Grazie allo strato protettivo impermeabile e resistente ai raggi UV con brillantezza satinata, la superficie trattata risulta resistente allo sporco.



Cod. art. Formato

1420 Lt.1



KLINKER & PFLASTER OL

IMPERMEABILIZZANTE PER KLINKER

Agisce ravvivando il colore e ripristinando la brillantezza senza brillare sottolineando la naturalezza del materiale e la struttura della superficie. Riduce la penetrazione di macchie e sporco.



Cod. art. Formato

1419 Lt.1



1-2 NATURAQUA PARKETTLACK

VERNICE PER PARQUET ALL'ACQUA

Ad alta resistenza, eco-compatibile per il trattamento di parquet.
 Catalizzabile con il Catalizzatore 4100-2K in rapporto vernice = 10 : 1
 con opportuna diluizione.
 Sviluppa alti livelli di protezione da usura e abrasione dei
 pavimenti in legno tradizionali, pre levigati o da ripristinare.



Cod. art.	15414	15415	15416	15417	15418
Lt.1	0/05	10/20	30/40	50/60	80/90



BORMA 1K-PU EASY PARKETTLACK

VERNICE PER PARQUET

Speciale come trattamento di fondo-finitura per il trattamento di parquet.
 A rapida essiccazione, è caratterizzata da ottima lavorabilità.
 Prodotto pronto all'uso.
 Può essere diluito fino al 15% con DPU011
 Diluente universale per Poliuretanic.



Cod. art.	15410	15411
Lt.1	10/20	30/40



RAVVIVANTE PER PARQUET

Formulato ecologico ed ipoallergenico a base di cere pregiate e polimeri
 in dispersione acquosa esente da VOC.
 E' di facilissima applicazione, si stende uniformemente, si asciuga
 rapidamente e ridona tono ed elasticità alle superfici di pavimenti
 in legno verniciato



Cod. art.	Formato
1591	Lt.1



NATURAQUA PARKETTREINIGER

SAPONE PER PARQUET

E' un detergente a base di sapone naturale a pH neutro, per la pulizia di pavimentazioni in legno verniciate o trattate ad olio. Adatto alla pulizia quotidiana.



PARKETTREINIGER

Cod. art.

Formato

1594

Lt.1



NATURAQUA PARKETTWACHS

CERA LUCIDANTE PER PARQUET

E' un'emulsione cerosa esente da solventi, ideata per la protezione ed il rinnovamento del parquet segnato dall'usura. Ideale per proteggere parquet trattati ad olio e verniciati.



PARKETTWACHS

Cod. art.

Formato

1595

Lt.1



LAMINATREINIGER

SAPONE DETERGENTE PER LAMINATI SPC

E' l'ideale per detergere e rinfrescare le pavimentazioni in laminato. La sua particolare formula ricca di sapone piacevolmente profumata, pulisce con efficacia i laminati plastici rispettandone l'aspetto originale.



LAMINATREINIGER

Cod. art.

Formato

1593

Lt.1



LAMINAT - WACHS

RAVVIVA LAMINATI SPC

Ravvivante ceroso all'acqua autolucidante speciale per rivitalizzare supporti in laminato, provati dall'usura e dal frequente calpestio. Idrosolubile, formaldeide esente, pressoché inodore.



LAMINAT WACHS

Cod. art.

Formato

1592

Lt.1



STONE COAT

PROTETTIVO SPECIALE PER PIETRA E MARMO

E' una vernice rivitalizzante a rapida essiccazione per marmi, travertini, pietre, graniti e agglomerati, che permette di ottenere un effetto bagnato, mettendo in evidenza il colore dei supporti.



STONE COAT

Cod. art.

Formato

078119

Lt.1



LA ROSSA CERA AUTOLUCIDANTE

Cera speciale all'acqua per la manutenzione di pavimenti in gres o in mattoni.



LA ROSSA CERA AUTOLUCIDANTE

Cod. art.

Formato

1599

Lt.1



UNICA CERA RILUCIDANTE

CERA RILUCIDANTE ALL'ACQUA

Lavaincera all'acqua è di facilissimo utilizzo. Piacevolmente profumata ed antiscivolo è indicata per la pulizia e protezione dei pavimenti in marmo, cemento e gres. Non indicato per legno e sughero.



UNICA CERA RILUCIDANTE

Cod. art.

Formato

1598

Lt.1



METALWACHS

CERA METALLIZZATA

Pronta all'uso, auto-lucidante all'acqua è l'ideale per pavimenti di marmo, piastrelle, linoleum e materiali plastici. Stesa uniformemente e lasciata agire attribuisce un piacevole velo protettivo di notevole brillantezza. Inodore, uso interno.



METALWACHS

Cod. art.

Formato

1597

Lt.1



CERA COTTO LIQUIDA

PER PAVIMENTI IN COTTO ALL'ACQUA

E' un prodotto di primissima qualità che accomuna ad una ottima resa un totale rispetto ecologico. La sua moderna formulazione auto-lucidante, ad alto contenuto di polimeri chiude i pori impermeabilizzando la superficie.



CERA COTTO LIQUIDA

Cod. art.

Formato

1596

Lt.1





Trattamento del legno

- Impregnanti
- Finiture
- Vernici
- Oli
- Vernici
- Ignifughe
- Detergenti
- Rinnovatore



BORMA WACHS®
Wood Professional Cosmetics



Impregnante fondo-finitura

Impregnante fondo-finitura all'acqua a base di resine e cere, ad alto contenuto solido con effetto gel, non cola; facile applicazione su superfici verticali. Penetra in profondità nel legno, esalta la struttura evidenziandone la venatura ed esaltandone il tono naturale. Le materie di prime di qualità, arricchite da filtri UV, prevengono il formarsi di muffe cromofore e l'attacco degli insetti lignivori.

Trattamento del Legno



Codice	ml.375	Codice	ml.750	Codice	Lt.2,5	Codice	Lt.10
21220	Neutro 08	21200	Neutro 08	21210	Neutro 08	212101	Neutro 08
21221	Noce 53	21201	Noce 53	21211	Noce 53		
212211	Noce 59	212011	Noce 59	212111	Noce 59		
212212	Noce 56	212021	Noce 56	212121	Noce 56		
21222	Noce 63	21202	Noce 63	21212	Noce 63		
21223	Ciliegio 16	21203	Ciliegio 16	21213	Ciliegio 16		
21224	Mogano 62	21204	Mogano 62	21214	Mogano 62		
21225	Teak 17	21205	Teak 17	21215	Teak 17		
212251	Rovere 03	212051	Rovere 03	212151	Rovere 03		
		212052	Rovere 52				
21226	Larice 10	21206	Larice 10	21216	Larice 10		
21227	Douglas 54	21207	Douglas 54	21217	Douglas 54		
21228	Pino 05	21208	Pino 05	21218	Pino 05		
21229	Bianco 50	21209	Bianco 50	21219	Bianco 50		
		212081	Verde 136				
		212091	Palissandro 58				
		212092	Wengè				



Naturaqua Holzwachs Lasur 3-in-1

Idrorepellente e traspirante, senza fenomeni di espulsione. Per rinnovare il supporto trattato è sufficiente applicare una mano sulla superficie asciutta e pulita, senza carteggiare preliminarmente.





Impregnante fondo-finitura

Holz wachs Lasur è una finitura a cera a base solvente, satinata, per interni ed esterni, a base di oli naturali, cere e resine. Diluibile con i prodotti della gamma Solvoil, penetra nel legno creando uno strato decorativo e protettivo di grande elasticità sulla superficie. Idrorepellente e traspirante, non presenta fenomeni di esfoliazione. Contiene filtri UV e additivi per la protezione del legno. Si consiglia l'applicazione in due o tre mani.



HOLZWACHS LASUR 150



HOLZWACHS LASUR 2,5

Codice	ml.750	Codice	Lt.2,5
21230	Neutro 08	21245	Neutro 08
21232	Noce 53	21246	Noce 53
21242	Noce 56		
21231	Noce 59	21247	Noce 59
21233	Noce 63	21248	Noce 63
21234	Ciliegio 16	21249	Ciliegio 16
21235	Mogano 62	21250	Mogano 62
21236	Teak 17	21251	Teak 17
21237	Rovere 03	21252	Rovere 03
21238	Larice 10	21253	Larice 10
21239	Douglas 54	21254	Douglas 54
21240	Pino 05	21255	Pino 05
21241	Bianco 50	21256	Bianco 50



Holz wachs Lasur 3-in-1

Idrorepellente e traspirante, senza fenomeni di esfoliazione. Per rinnovare il supporto trattato è sufficiente applicare una mano sulla superficie asciutta e pulita, senza carteggiatura preliminare.



Trattamento del Legno



neutro 08 Noce chiaro 53 Noce dorato 56 Noce medio 59 Noce scuro 63 Ciliegio 16 Mogano 62



Teak 17 Rovere 03 Larice 10 Douglas 54 Pino 05 Bianco 50

IMPREGNANTE DECORATIVO ALL'ACQUA

Impregnante non filmogeno all'acqua a base di resine ed oli. Penetra in profondità nel legno, esalta la struttura, e ne evidenzia la venatura attribuendone un tono acceso e vivace. Le materie prime di qualità, arricchite da filtri UV, prevengono il formarsi di muffe cromofore e l'attacco degli insetti lignivori.



IMPREGNANTE DECORATIVO A SOLVENTE

Impregnante protettivo e decorativo classico, per interni ed esterni, inodore, a residuo secco medio e di facile stesura. Conferisce colore al legno esaltandone la struttura. Contiene filtri UV ed additivi che forniscono una protezione efficace contro gli agenti nocivi del legno.



Codice	ml.750	Codice	Lt.2,5
21120	Neutro 08	21130	Neutro 08
21121	Noce 53	21131	Noce 53
21122	Noce 63	21132	Noce 63
21123	Ciliegio 16	21133	Ciliegio 16
21124	Mogano 62	21134	Mogano 62
21125	Teak 17	21135	Teak 17
21126	Larice 10	21136	Larice 10
21127	Douglas 54	21137	Douglas 54
21128	Pino 05	21138	Pino 05
21129	Bianco 50	21139	Bianco 50



Codice	ml.750	Codice	Lt.2,5
21100	Neutro 08	21110	Neutro 08
21101	Noce 53	21111	Noce 53
211011	Noce 59		
21102	Noce 63	21112	Noce 63
21103	Ciliegio 16	21113	Ciliegio 16
21104	Mogano 62	21114	Mogano 62
21105	Teak 17	21115	Teak 17
21106	Larice 10	21116	Larice 10
21107	Douglas 54	21117	Douglas 54
21108	Pino 05	21118	Pino 05

Trattamento del Legno



NATURAQUA TOP GEL 30

Finitura incolore non sfogliante all'acqua per legno, a base di resine ad alta flessibilità per la protezione e l'abbellimento del legno. Interno/Esterno Con filtri UV. Le preziose sostanze che lo compongono abbinata ai filtri UV, impediscono il formarsi di muffe cromofore e prevengono l'attacco degli insetti lignivori.

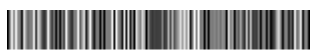

Codice	ml.750	Codice	Lt.2,5
21160	Neutro 08	21170	Neutro 08
21161	Noce 53	21171	Noce 53
21162	Noce 63	21172	Noce 63
21163	Mogano 62	21173	Mogano 62
21164	Teak 17	21174	Teak 17
21165	Larice 10	21175	Larice 10
21166	Douglas 54	21176	Douglas 54
21167	Pino 05	21177	Pino 05
21168	Ciliegio 16	21178	Ciliegio 16
21169	Bianco 50	21179	Bianco 50

NATURAQUA DEKORWACHS

E' una finitura alto solido a base acqua, satinata, adatta sia per interno che per esterno, dotati di un eccellente potere coprente ed una elevata resistenza alla luce. Il prodotto è pronto all'uso, dimostra eccellente elasticità e rapidità di essiccazione. A base di resine e cere di alta qualità, filtri UV e preservanti, protegge il legno dagli agenti atmosferici.



Codice	ml.750	Codice	Lt.2,5
21300	Bianco 50	21310	Bianco 50
		Codice	Lt.10
		21320	Bianco 50

Naturaqua Dekorwachs Lasur 3-in-1

Finitura ad acqua coprente ad alto solido, basata su cere e resine di alta qualità, filtri UV e Conservanti, protegge il legno dagli agenti biologici e dalla intemperie. Il prodotto è facile da applicare, non solo anche su superfici verticali.



neutro 08 Noce chiaro 53 Noce scuro 63 Ciliegio 16 Mogano 62



Teak 17 Larice 10 Douglas 54 Pino 05 Bianco 50

FLATTING EXTRA MARINE VERNICE NAUTICA

Vernice speciale a solvente per nautica pronta all'uso.



Cod. art.	1265.41	21180	21182	21184
Lucido	ml.125	ml.375	ml.750	lt.2,5
Cod. art.	1265.42	21181	21183	21185
Opaco	ml.125	ml.375	ml.750	lt.2,5



NATURAQUA FLATTING EXTRA MARINE

Vernice speciale all'acqua per nautica pronta all'uso



Cod. art.	12816	21190	21192	21194
Lucido	ml.125	ml.375	ml.750	lt.2,5
Cod. art.	12817	21191	21193	21195
Opaco	ml.125	ml.375	ml.750	lt.2,5



FIRE STOP PQ BORMA PRO

Vernice ignifuga per pavimenti

Vernice poliuretana bicomponente **RITARDANTE DI FIAMMA** per interni, da usarsi come fondo finitura su pavimenti di legno e su legno in generale. Certificato in **EUROCLASSE Bfl-s1** in accordo alla normativa **EN 13501-1:2009** dall' **ISTITUTO GIORDANO SpA**. Il prodotto deve essere utilizzato rispettando le seguenti riportate in scheda tecnica.



Cod. art.	21500	21501
formato	Lt.1 + catalizzatore	Lt.5 + catalizzatore



NATURAQUA EXTRA STRONG WOOD CLEANER

Detergente intensivo del legno, libera da sporco ostinato e residui di precedenti trattamenti a base olio o impregnanti/finiture sintetiche. Per ripristinare il colore originale del legno, utilizzare successivamente Exterior Wood Cleaner.



Cod. art.

formato

15349

Lt.1



NATURAQUA EXTERIOR WOOD CLEANER

Detergente a base acqua monocomponente. Consente di pulire efficacemente e preparare la superficie prima di successivi trattamenti, rimuovendo i residui di sporco ed schiarendo il colore del legno.



Cod. art.

15347

15348

Formato

Lt.1

Lt.5



TERRACE OIL DECKING OIL

Olio naturale per esterni

Conferisce una protezione efficace e traspirante senza fenomeni di esfoliazione e con un effetto satinato naturale.



Cod. art.

15352

15353

formato

Lt.1

Lt.5



RINOVA FONDO RINNOVATORE

E' un fondo uniformante, inodore, pronto all'uso di eccezionale copertura, ideale per il ripristino del legno esposto in esterno.



Cod. art.

15385

ml.750

Pino

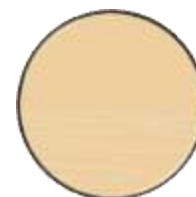

TEAK OIL BORMA EXTERIOR

Prodotto a base di olio, pronto all'uso, adatto a tutte le superfici in legno sia per interno che per esterno. Conferisce idrorepellenza.



TEAK OIL



ml.500



Cod. art.	3209	3208
formato	Lt.1	Lt.5

SAUNA OIL

Protettivo per saune a zero emissioni, per il trattamento e la manutenzione delle superfici interne delle saune.



Cod. art.	32071
formato	ml.500



SAUNA OIL



HARD TOP OIL

Olio per superfici da tavola e piani da cucina in genere, come anche taglieri ed utensili in legno.



Cod. art.	3227
formato	ml.750



HARD TOP OIL



KITCHENWARE OIL

Olio esente da VOC, destinato a venire in costante contatto con gli alimenti, come piani di tavoli da cucina.



Cod. art.	3228	3229
formato	Lt.1	ml.250



KITCHENWARE OIL



TUNG OIL OLIO DI LEGNO

Ideale per la finitura del legno e per la preparazione di pitture ed inchiostri ad olio.



Cod. art.	32073
formato	ml.500



TUNG OIL



A close-up photograph of a hand using a light-colored cloth to clean a dark wooden surface. The wood has a prominent grain and a brass knob is visible in the upper part of the frame. The lighting is warm, highlighting the texture of the wood and the hand.

Restauro legno & doratura

- Ritocchi a vernice
- Ritocchi a cera
- Sbiancante
- Consolidanti
- Patina anticante
- Fondi e finitura per doratura
- Turapori
- Gommalacca
- Cere solide
- Olio restauro
- Lana acciaio
- Foglia oro
- Metallo liquido
- Shabby provenzale
- Resine epossidiche



BORMA WACHS[®]

Wood Professional Cosmetics

STUCCO A CERA



STUCCO A CERA

Cod. art. **0851**

Formato Gr.20



Tanganica

Wengè 146



Bianco 50

Blu 140

Ciliegio 16

Castagno 49

Douglas 54

Frassino 65



Grigio 103

Larice 10

Mogano 62

Nero 60

Naturale 08

Palissandro 58



Noce chiaro 53

Noce medio 59

Noce scuro 63

Noce antico 14

Rovere scuro 52

Teak 17

PENNARELLO RITOCO LEGNO

Cod. art.

3205



PENNARELLO RITOCO LEGNO



Ciliegio medio 30

Ciliegio chiaro 29

Ciliegio pero 16

Castagno 49

Douglas 54

Pino 05

Mogano chiaro 36

Mogano scuro 33

Wengè 146

Teak 17

Rovere scuro 52

Rovere chiaro 51

Noce chiaro 53

Noce medio 59

Noce scuro 63

Palissandro 58

Tanganica 60

Bruno 46

RITOCCHO TINTA VERNICE



RITOCCHO TINTA VERNICE



ESPOSITORE RITOCCHO LEGNO «A»

Allestimento

- 10 - Bastoncini di Stick cera in 10 colori
- 05 - Pennarelli Profix in 10 colori
- 05 - Ritocco Liquido 30 ml. in 10 colori
- 08 - Cera in pasta da 500 ml Neutro e Noce
- 10 - Cera d'api liquida da 250 ml Neutro e Noce

Dimensioni: cm.41x107x27

Cod. art. 3203



ESPOSITORE RITOCCHO LEGNO A



ESPOSITORE RITOCCHO LEGNO «C»

Allestimento

- 5 - Pennarello Profix in 10 colori assortiti

Dimensioni: cm.30x15x10

Cod. art. 3200



ESPOSITORE RITOCCHO LEGNO C



HOLZFARBE COLORANTE PER LEGNO

COLORANTE CONCENTRATO

Colorante ideale per la tinteggiatura di tutte le superfici interne in legno grezze. Le numerose tonalità di produzione donano brillantezza al legno esaltandone la venatura. Il concentrato è pronto all'uso e le sue caratteristiche lo rendono l'ideale sostitutivo delle classiche (polveri) aniline evitando pre lavorazioni e nocive ispirazioni di polveri. La sua soluzione può essere diluita con qualsiasi solvente, alcool, acetone, diluente o acqua con un massimo rapporto di 1 a 6.

ROSSO 125	ROVERE 52	TANGANICA
VERDE 134	ARANCIO 122	BLU 140
NOCE CHIARO 53	NOCE MEDIO 59	NOCE SCURO 63
CILIEGIO 30	GIALLO 120	MOGANO 62
TEAK 17	NERO 60	WENGE' 146
	Cod. art.	0843
PALISSANDRO 58	Formato	ml.250



MORDENTI SOLUBILI

Il Mordente Colibri è un tintura professionale in polvere solubile in acqua e alcol, ideale per colorare oggetti in legno e sughero. La tintura Mordente è specifica per fissare il colore sulle fibre del legno rendendolo della tonalità del colore prescelto, ottimi per la colorazione delle suole di calzature.

Colori ad alcool: codice 8685

Bruno noce medio 038
Rosso mogano 062
Bruno noce scuro 015
Nero ebano C125
Bruno noce chiaro 022
Palissandro 099
Quercia chiaro/teak 006
Ciliegio 059
Blu puro 068
Rosso fuoco 061
Arancio giallastro 053
Verde oliva 072
Giallo puro 071



Colori ad acqua codice 8685

Blu 036
Verde erba 046
Quercia chiaro/teak 010
Rosso mogano chiaro 014
Arancio giallastro 045
Bruno noce medio 038/A
Nero ebano 025/A
Rosso fuoco 023
Bruno noce scuro 003
Ciliegio 021
Bruno noce chiaro 041
Giallo puro 027
Palissandro 035



Terre in polvere, largamente usate nell'ambito del restauro tradizionale. Vengono applicate in soluzione acquosa, in quantità variabile a seconda dell'intensità di tono desiderata. Esclusivo uso interno.



Cod. art.	8182	8187
Colore	Noce gr.500	Mogano kg.1

LANA NAZIONALE

GRANA GROSSA

La Lana d'Acciaio è un prodotto per l'industria, per l'artigiano e per la semplice manutenzione domestica del legno. Composta da filamenti extra-sottili, controllati con un sistema computerizzato, la lana d'acciaio è perfetta per l'applicazione di cere o oli con conseguente lucidatura del supporto.

Cod. art. 1753.1



Formato 4 x 2,5 kg



LANA MOBILIERI

GRANA «00»

La Lana d'Acciaio è un prodotto per l'industria, per l'artigiano e per la semplice manutenzione domestica del legno. Composta da filamenti extra-sottili, controllati con un sistema computerizzato, la lana d'acciaio è perfetta per l'applicazione di cere o oli con conseguente lucidatura del supporto.

Cod. art. 1753.2



Formato 2 x 5 kg



LANA MOBILIERI

GRANA «000»

La Lana d'Acciaio è un prodotto per l'industria, per l'artigiano e per la semplice manutenzione domestica del legno. Composta da filamenti extra-sottili, controllati con un sistema computerizzato, la lana d'acciaio è perfetta per l'applicazione di cere o oli con conseguente lucidatura del supporto.

Cod. art. 1753.3



Formato 2 x 5 kg



LANA MOBILIERI

GRANA «0000» EXTRA FINE

La Lana d'Acciaio è un prodotto per l'industria, per l'artigiano e per la semplice manutenzione domestica del legno. Composta da filamenti extra-sottili, controllati con un sistema computerizzato, la lana d'acciaio è perfetta per l'applicazione di cere o oli con conseguente lucidatura del supporto.

Cod. art. 1753.7



Formato 1 kg



SBIANCANTE PER LEGNO

Prodotto bicomponente ideale per la sbiancatura delle superfici in legno.

COMPLETO DI CATALIZZATORE



Cod. art. 15342

Formato Lt.1 + ml.500



SBIANCANTE PER LEGNO

HOLZ HARTER

CONSOLIDANTE PER LEGNO

Dispersione, pronta all'uso, di resine acriliche in solvente a rapida essiccazione, per rinforzare ed indurire ogni tipo di legno indebolito da insetti o usurato dal tempo.



Cod. art. 1363

Formato Lt.1



HOLZ HARTER

FONDO TURAPORI AD ACQUA

Speciale per il trattamento del mobile preliminare alla finitura con Mobilack.



Cod. art. 15390

Formato Lt.1



FONDO TURAPORI

TURAPORI IN GEL

Fondo monocomponente ideale come prima mano nella verniciatura o quale base per un trattamento a cera.



Cod. art.

0882

0883

08831

Formato

ml.250

ml.750

Lt.5



TURAPORI IN GEL

NATURAQUA MOBILACK

Fondo finitura per mobili ad acqua. Utilizzabile come prodotto monocomponente o catalizzabile con il Catalizzatore 4100-2K in rapporto vernice: catalizzatore = 10 : 1.



Cod. art.	15370	15371	15372
Lt.1	Opaco assoluto Gloss 0/05	Opaco Gloss 30/40	Semilucido Gloss 50/60



NATURAQUA MOBILACK

NATURAQUA INVISIBLE TOUCH

Finitura ecologica, resino cerosa ad acqua, per la protezione delle superfici in legno. Può essere addizionato con il catalizzatore 4100-2k, in rapporto : catalizzatore 10:1.



Cod. art.	15361
Lt.1	Opaco profondo Gloss 0



NATURAQUA INVISIBLE TOUCH

SUPER WOOD SEALER NATURAQUA

Idrorepellente isolante all'acqua di fondo per il pretrattamento delle superfici in legno. Ideale come primo trattamento di fondo specialmente su legni ad alto contenuto di tannino.



Cod. art.	15380	15381	Cod. art.	15382
ml.750	Neutro	Bianco	Lt.5	Bianco



SUPER WOOD SEALER NATURAQUA

CATALIZZATORE 4100-2K

Additivo per la corretta catalisi delle vernici all'acqua per conferire al trattamento elevate resistenze al calpestio e allo sporco.

- Mobilack
- Invisible touch
- Parkett lack
- Turapori



Cod. art.	15375	15376
Lt.1	ml.100	ml.500



CATALIZZATORE 4100-2K

HARD TOP POLISH NATURAL

VERNICE ALLA GOMMA LACCA

Prodotta con Gommalacca decerata naturale e resine completamente naturali.

Ideale per tutti quei supporti soggetti a forte usura e sui quali non si vuol rinunciare all'unicità estetica della gommalacca. Pronta all'uso ed incolore, può essere colorata con l'aggiunta di piccole quantità di colorante concentrato.



Cod. art.	3226	3225
Formato	Lt.1	Spray ml.400

VERNICE A TAMPONE DI GOMMALACCA

GOMMALACCA DECERATA

A base di pura gommalacca naturale è pronta all'uso e di colore ambrato. E' formulata seguendo le più antiche tradizioni di verniciatura. Le pregiate essenze naturali contenute, nel totale rispetto dell'ambiente consentono trattamenti protettivi d'estrema brillantezza e piacevole morbidezza, su tutte le superfici di legno interne.



Cod. art.	3220	3221
Formato	ml.500	Lt.1

GOMMALACCA IN SCAGLIE

Gommalacca naturale in scaglie per la preparazione individuale di vernici a tampone o complementi di finitura per il restauro.



Cod. art.	8363	8362	8361
Formato	Kg.1	Kg.5	Kg.25

CERA D'API PURA

Di colore giallo dorato, lievemente caratterizzata dal suo tipico aroma è perfetta per candele o per patine cerose. La cera d'api naturale è purissima e di altissima qualità, purificata dalla maggior parte delle impurità, ha un basso contenuto d'olio, così da non ungere al tatto senza comprometterne l'elasticità.



CERA API PURA

Cod. art. **8344.1** **8344**

Formato Gr.200 Kg.1

CERA CARNAUBA

Solubile in solventi comuni (tremontina, aromatici, ecc.) È la cera naturale più dura che si conosca e ha un punto di fusione molto alto (80-87 °C). Viene utilizzato nel restauro per ceretta, verniciatura, come ingrediente per impasti, come lucidatrici, e in molti altri campi di applicazione.



CERA CARNAUBA

Cod. art. **8345**

Formato Kg.1

PARAFFINA SOLIDA

PURA 100% , raffinata, bianca traslucida, inodore, leggermente untuosa al tatto, perfetta per la fabbricazione di candele, di colle termo fusibili e per il trattamento della carta. Ottima quale scivolante da applicarsi fra supporti a rischio di attrito.



PARAFFINA SOLIDA

Cod. art. **8349** **8348**

Formato Gr.200 Kg.5

COLLA IN PERLE

La colla d'ossa è un solido di colore bruno-giallo in forma di perle, ottenuto da estratti animali. E' la colla tradizionale, usata da sempre dai falegnami per l'incollaggio dei giunti e degli incastri, in aggiunta all'utilizzo dei semplici chiodi.



COLLA IN PERLE

Cod. art. **8370**

Formato Kg.1

GESSO BOLOGNA

Il Gesso Bologna viene utilizzato nella doratura per preparare uno specifico fondo per la preparazione della superficie da decorare con foglia oro.



GESSO BOLOGNA

Cod. art. **06751** **0675**

Formato Kg.2 Kg.25

COLLA DI CONIGLIO

La colla di coniglio è un collante naturale, derivato da estratti proteici di origine animale. Viene utilizzata nella realizzazione di numerosi prodotti per la doratura e per il restauro in genere.



COLLA DI CONIGLIO

Cod. art. **8380**

Formato Kg.1

CERA NEUTRO UNIVERSAL

E' una miscela di cere naturali e sintetiche, trasparenti, indicate per il trattamento dello stucco veneziano, del parquet e del marmo.



CERA NEUTRO UNIVERSAL



Cod. art.	1531	1530 B
Formato	ml.500	Lt.1

OLIO CERA DURA 7030

HARTWACHS ÖL 7030

A base di cere ed oli naturali, il prodotto associa la facilità di applicazione della cera in pasta con la resistenza dell'olio. Incolore



OLIO CERA DURA 7030



Cod. art.	15260
Formato	ml.750

CERA STUCCHI LA VENEZIANA

A base di cere naturali disperse in acqua, esente formaldeide, nutre, rigenera, è l'ideale per la lucidatura degli stucchi veneziani. Idrosolubile, CERT. EN 71 (PAR III), lascia una piacevole morbidezza superficiale dal gradevole profumo.



CERA STUCCHI LA VENEZIANA



Cod. art.	1534
Formato	ml.750

LIMING WAX

Cera pigmentata formulata con pura cera d'api e carnauba, arricchisce e nutre ogni superficie in legno. Con i suoi pigmenti protegge conferendo un effetto antico decapato al mobile trattato. COLORE BIANCA



LIMING WAX



Cod. art.	1525
Formato	ml.375

BORMA HOLZ WACHS

CERA D'API E CARNAUBA MORDENZATA

Borma Holz wachs nutre, rigenera, protegge e lucida ogni tipo di legno, particolarmente indicato per mobili pregiati.



Cod. art. **1523**

Formato ml.500

MOBILCERA

E' una crema per mobili che ridona con facilità un piacevole splendore ai mobili di aspetto stanco ed opaco.

Le preziose sostanze, di cui è ricca la crema per interni, rigenerano il mobile antico.



Cod. art.

15480

Formato

ml.250



MOBILCERA



Cartella colori



Neutra
08



Gialla
120



Mogano
62



Ciliegio
30



Nera
60



Noce chiaro
53



Noce medio
59



Noce scuro
63



Rovere
scuro 52



BORMA HOLZ WACHS



HOLZWACHS FLUSSIG

Cera liquida naturale a base di Cera d'Api e Carnauba. Pronta all'uso, neutra, nutre e protegge ogni tipo di legno avviando con successo al formarsi di crepe, rigonfiamenti o sgradevoli sbiadimenti ed esaltandone la naturale bellezza.



Cod. art.

1522N

Formato

ml.500



HOLZWACHS FLUSSIG

OLIO RESTAURO

Prodotto speciale in antiquariato per il mantenimento del mobile. Penetrando in profondità, tinge e lucida, coprendo graffi e abrasioni.



Legno scuro

Mogano



legno chiaro

legno medio



Cod. art. **1524**

Formato ml.150



OLIO RESTAURO

DETERGENTE NEUTRO PER MOBILI

A base di olio essenziale d'arancio e a pH neutro, è ottimo per la pulizia di mobili in legno verniciati o trattati ad olio. Rimuove con efficacia sporco e grasso, senza intaccare le vernici.



Cod. art. **15345**

Formato ml.500



DETERGENTE NEUTRO PER MOBILI

OLIO RIGENERANTE PER INFISSI

È indicato per finestre, porte, perline e travi in legno. Per superfici trattate sia ad olio o vernice.



Cod. art. **15358** **15359**

formato ml.500 Lt.1



OLIO RIGENERANTE PER INFISSI

RIVITALIZZANTE PER INFISSI

Ad acqua con resine acriliche. Per la manutenzione di infissi in legno, PVC e alluminio. Per uso interno/esterno



Cod. art. **15346**

formato ml.500



RIVITALIZZANTE PER INFISSI

OLIO PAGLIERINO CHIARO

L'olio paglierino Borma Wachs è un olio adatto nelle fasi di pulizia, lucidatura e nutrimento della fibra, grazie al suo ottimo potere penetrante.



OLIO PAGLIERINO CHIARO

Cod. art.	1470	1471	1472
Formato	ml.200	ml.500	Lt.1

OLIO PAGLIERINO ROSSO

L'olio paglierino Borma Wachs è un olio di largo utilizzo nell'ambito del restauro. Nella versione pregiata rossa è ottimo per ristabilire il colore originale di legno e pietra.



OLIO PAGLIERINO ROSSO

Cod. art.	1480	1481	1482
Formato	ml.200	ml.500	Lt.1

OLIO NUTRILEN TIMPEST

Rigenera, ravviva, nutre.
Deterge il legno.
Per uso interno/esterno



Cod. art.	1752.1
formato	ml.500



OLIO NUTRILEN TIMPEST

SPOLVEROL TIMPEST

Pulente, lucidante. Antistatico.
Per metalli, laminati e plastiche



Cod. art.	1752.3
formato	ml.250



SPOLVEROL TIMPEST

ANTITARLO TIMPEST



- ✓ Antitarlo specifico per la lotta contro i tarli del legno
- ✓ Non danneggia le vernici
- ✓ Per tutte le superfici del legno sia interne che esterne
- ✓ **Presidio Medico Chirurgico Reg. n° 18744 del Ministero della Salute**

Cod. art.	1749.0	1749.1	1749.2
Formato	ml.250 spray	ml.500	Lt. 1
	1749.3	1749.4	1749.5
	Lt.2,5	Lt.10	Lt.25



AQUA ANTITARLO TIMPEST



- ✓ Antitarlo a base d'acqua
- ✓ Specifico per la lotta contro i tarli del legno
- ✓ Non danneggia le vernici
- ✓ Per tutte le superfici del legno sia interne che esterne
- ✓ **Presidio Medico Chirurgico Reg. n° 18744 del Ministero della Salute**

Cod. art.	17541	17542
Misure	Lt.1	Lt.3



ANTITARLO COMPLET



- ✓ Antitarlo speciale per la protezione di mobili antichi
- ✓ Cornici, travature, pavimenti in parquet
- ✓ **Presidio Medico Chirurgico Reg. n° 18563 del Ministero della Salute**

Cod. art.	17410	17411
Misure	ml.200	ml.500
	17412	17413
	Lt. 1	Lt.5



HOLZ 2000



- ✓ Antitarlo speciale per la protezione di mobili antichi
- ✓ Cornici, travature, pavimenti in parquet
- ✓ Completo di siringa

Cod. art.	15420
Misure	ml.250



DIVER SGRASSANTE PER METALLI

- ✓ Prodotto gelatinoso
- ✓ Per superfici in legno e metallo
- ✓ Asporta facilmente tutti i tipi di vernice



Cod. art.	1309	1310	1311
Misure	ml.750	Lt.4	Lt.17



DIVER SVERNICIATORE ECOLOGICO

- ✓ Prodotto in gel
- ✓ Adatto per legno, metallo e murature
- ✓ Asporta facilmente tutti i tipi di vernice



Cod. art.	1317	1318
Misure	ml.750	Lt.4



RADIKAL ABBEIZER

- ✓ Sverniciatore in gel
- ✓ Adatto per legno, metallo e murature
- ✓ Asporta facilmente tutti i tipi di vernice
- ✓ **Esente da cloruro di metilene**



Cod. art.	1315	1316
Misure	ml.750	Lt.4



AMMONIACA 28Bè

- ✓ Altamente concentrata al 30-32% di gas (NH3)
- ✓ Per la rimozione di macchie ostinate



Cod. art.	0264
Formato	lt.1



COPPER LACK



METALLO LIQUIDO PER ESTERNO

Vernici metallizzate, specifiche per l'utilizzo in ambienti esterni, caratterizzate da buona brillantezza e resistenza, adatte per la decorazione.



Cod. art. 19221

Rame 21 ml.125



SHINE DECOR GOLD LACK



METALLO LIQUIDO PER INTERNO

Finitura speciale brillante a solvente, che ripropone i colori tradizionali della doratura.



Cod. art. 19224

Oro cromo 11F ml.125



Cod. art. 19227

Argento cromo 15F ml.125



GOLD LACK



METALLO LIQUIDO PER ESTERNO

Finitura speciale brillante a solvente, che ripropone i colori tradizionali della doratura.



Cod. art. 19248

Oro ricco 11 ml.125



Cod. art. 19249

Oro pallido 24 ml.125



SILVER LACK



METALLO LIQUIDO – interno/esterno

Finitura speciale brillante a solvente, che ripropone i colori tradizionali della doratura.



Cod. art. 19251

Argento 15 ml.125



Cod. art. 19252

ml.375



Cod. art. 19253

ml.750



SHINE DECOR GOLD LACK



METALLO LIQUIDO PER INTERNO

Finitura speciale brillante a solvente, che ripropone i colori tradizionali della doratura.



Cod. art. 19201

ml.125 Oro ricco 11



Cod. art. 19215

Oro ricco pallido 23



Cod. art. 19211

Oro pallido 24



Cod. art. 19218

Oro ducato brillante 28



SHINE DECOR GOLD LACK



METALLO LIQUIDO PER INTERNO

Finitura speciale brillante a solvente, che ripropone i colori tradizionali della doratura.



Cod. art.

19202

Oro ricco 11

ml.375



Cod. art.

19212

Oro pallido 24

ml.375



SHINE DECOR GOLD LACK



METALLO LIQUIDO PER INTERNO

Finitura speciale brillante a solvente, che ripropone i colori tradizionali della doratura.



Cod. art.

19203

Oro ricco 11

ml.750



Cod. art.

19213

Oro pallido 24

ml.750



NATURAQUA GOLD LACK



METALLO LIQUIDO PER ESTERNO

Finitura speciale brillante a solvente, che ripropone i colori tradizionali della doratura.



Cod. art.

19230

ml.125

Oro 11



19233

Oro 24



19236

Oro 23



19239

Oro 28



COPPER LACK



METALLO LIQUIDO PER ESTERNO

Vernici di finitura rame per interno. Vernici metallizzate, all'acqua, indori ed ecologiche, dalla buona brillantezza e resistenza.



Cod. art.

19242

Rame

ml.125



SILVER LACK



METALLO LIQUIDO PER INTERNO/ESTERNO

Finitura speciale all'acqua, che ripropone il tradizionale color argento.

Può essere usata su tutti i tipi di legno, grezzo o trattato, come pure muratura, gesso e metallo.



Cod. art.

19245

Argento

ml.125



SHABBY PROVENZALE - DECORGESSO ANTICANTE

Pittura a base di gesso naturale e polimero acrilico, adatta a superfici in legno e superfici murarie. Grazie all'alto contenuto solido permette di ottenere un ottimo riempimento, rendendo i supporti omogenei con un numero di applicazioni ridotto. Di buona dilatazione e flessibilità, offre, quando carteggiato, la possibilità di finiture perfettamente lisce. Sovraverniciabile con vernici ad acqua e a solvente, cere, vernici alla gommalacca. Le colorazioni e la sua particolare formula rendono Shabby Provenzale particolarmente adatto all'ottenimento di finiture in stile provenzale e shabby chic.



1969
Cartella
colori



SHABBY PROVENZALE

Cod. art.	Formato
1970	ml.375
1972.50	Lt.2,5 Bianco



Restauro Legno & Doratura

BIANCO NEVE 50	BIANCO GRIGIO 822	BIANCO CRETA 9001	AVORIO 08	GRIGIO CHIARO 100	GRIGIO SETA 7014	GRIGIO AZZURRO 2005
GRIGIO 101	GRIGIO SCURO 107	GRIGIO AMBRA 109	GRIGIO FUMO 152	ANTRACITE 145	NERO 60	TORTORA 116
GIALLO SABBIA 129	GIALLO PASTELLO 1034	GIALLO OSSIDO 120	GIALLO LIMONE 119	VERDE OLIVA CHIARO 81	VERDE OLIVA 31	VERDE SALVIA 133
VERDE PRIMAVERA 132	VERDE MENTA 130	VERDE FORESTA 137	BLU CIELO 142	AZZURRO PROVENZA 153	AZZURRO 144	BLU ACQUA MARINA 150
BLU PROFONDO 148	ROSSO CORALLO 125	ROSA ANTICO 1515	VIOLA 127	ROSSO MATTONE 128	ROSA 126	ARANCIO IBISCO 122

ANTIK PATINA

PATINA ANTICANTE

A base di bitume giudaico è l'ideale per attribuire con facilità ad ogni superficie in legno un aspetto antico e patinato.



ANTIK PATINA

Cod. art. **3235**

Formato ml.500



BORMA GLASS 2K

RESINA EPOSSIDICA

Speciale formulato a base epossidica bicomponente caratterizzato da una eccezionale trasparenza, adatto per riempire cavità ed imperfezioni in materiali di varia natura.

[Completo di catalizzatore](#)



BORMA GLASS 2K

Cod. art. **15400**

Formato 1 kg. + ml.400



GLITTER IN GEL

Glitter in poliestere progettato per serigrafia, rivestimento e decorazione.

[BARATTOLO da ml.180](#)



GLITTER IN GEL



Cod. art. **1966**

Colori Oro grana grossa

1960

Oro grana fine

1961

Argento grana fine

1965

Argento grana grossa

1962

Argento olografico Grana fine

MISSIONE AD ACQUA

E' una colla acrilica idrosolubile, da utilizzare per la corretta applicazione della foglia d'oro e d'argento di tutte le carature.



Cod. art.	15296	15298
Formato	ml.150	Lt.1



FOGLIA ORO IMITAZIONE

Foglie di spessore molto sottile a base di leghe di metalli puri ideali per conferire effetti speciali metallizzati a qualsiasi tipo di superficie.



Cod. art.	15290	15291
Formato	cm 16 x 16 fg.500	cm 14 x 14 fg.25



FOGLIA ARGENTO IMITAZIONE

Foglie di spessore molto sottile a base di leghe di metalli puri ideali per conferire effetti speciali metallizzati a qualsiasi tipo di superficie.



Cod. art.	15295	15293
Formato	cm 16 x 16 fg.500	cm 14 x 14 fg.25



PATINA PER DORATORI

Miscela di cere di origine minerale, animale e vegetale con l'aggiunta di polveri metalliche.



Cod. art.	15270
Formato	Oro ml.300



ZAPON LACK

E' una vernice al solvente lucida di finitura ad alta resistenza superficiale per supporti dorati.



Cod. art.	15280
Formato	ml.500





Detergenza & Chimica

- Creme lucidanti
- Pasta abrasiva
- Saponi
- Sgrassatori
- Rimuovi alghe
- Rimuovi malta e pitture
- Smacchiatori
- Rimuovi etichette
- Oli rigeneranti
- Sacchi pattumiera
- Carta asciugatutto



DRY POLISH

CREMA LUCIDANTE

Fluida a base acqua per donare a vernici un lucido ineguagliabile.



DRY POLISH

Cod. art. **0591**

Formato ml.250

ABRASIVE SHINING

PASTA ABRASIVA

Con leggera azione abrasiva è ottima per eliminare piccoli graffi da tutti i tipi di vernice.



ABRASIVE SHINING

Cod. art. **0581** **0582**

Formato ml.125 ml.500

MAGIX POLIER REINIGER

Pulisce e lucida con profumo di agrumi. Ottimo in gioielleria, materie plastiche. Particolarmente efficace su inox, rame, ottone, oro e argento.



MAGIX POLIER REINIGER

Cod. art. **1423**

Formato ml.300

IOSSO POLISHING CREAM

Crema lucidante per argento, inox, alluminio, ottone, rame, bronzo, oro e cromature. Ottimo anche su vetroresina, plastiche. **Ad eccezione del plexiglas**



IOSSO POLISHING CREAM

Cod. art. **0945** **0946**

Formato ml.50 ml.250

SAPONE LIQUIDO PERLA HOUSE

Detergente per lavare, smacchiare e pulire pellami lisci, scamosciati e tessuti.



SAPONE LIQUIDO PERLA HOUSE

Cod. art. **0943**

Formato ml.250

CREMA NUTRIENTE PERLA HOUSE

Delicata e fine per detergere, lucidare e nutrire i pellami lisci in vitello, nappe etc



CREMA NUTRIENTE PERLA HOUSE

Cod. art. **0944**

Formato ml.250

GRILL REINIGER

PULITORE PER BARBEQUE

Scioglie in modo rapido e affidabile anche i residui di incrostazione, grasso e frittura ostinati e bruciati, nonché lo sporco oleoso. Forte effetto dovuto alla struttura del gel.



GRILL REINIGER

Cod. art. 1416

Formato ml.750



KAMIN UND OFENGLAS

PULITORE PER CAMINI

Pulitore pronto all'uso per rimuovere depositi di fuliggine, residui di carburante, grasso e sporco ostinato dai vetri del camino e del forno.



KAMIN UND OFENGLAS

Cod. art. 1417

Formato ml.750



AUFKLEBER ENTFERNER

RIMUOVI ADESIVI

Combinazione efficace di principi attivi per un delicato distacco e rimozione completa di adesivi autoadesivi e appiccicosi, etichette e residui adesivi. Anche per facilitare la rimozione di inchiostro, grasso, olio, catrame e fuliggine.



AUFKLEBER ENTFERNER

Cod. art. 1424

Formato ml.500



SILIKON ENTFERNER

RIMUOVI SILICONE

Formula in gel – anche per superfici verticali
Set completo: 150 ml di prodotto
1 pennello
1 spugna speciale



SILIKON ENTFERNER

Cod. art. 0960

Formato ml.150



ROSTFLECKEN ENTFERNER

RIMUOVI RUGGINE

Per eliminare macchie di ruggine e altri residui di ossidazione su tutte le superfici in pietra naturale e artificiale, piastrelle e ceramica.



ROSTFLECKEN ENTFERNER

Cod. art. 1415

Formato ml.750



GRAFFITI EX

RIMUOVI GRAFFITI

Rimuove imbrattature colorate e graffiti. Lo spray pronto all'uso dissolve vernici spray, pitture e pennarelli su tutti i supporti resistenti ai solventi come metallo, vetro, legno, piastrelle, ecc.



GRAFFITI EX

Cod. art. 0965

Formato ml.500



KUNSTOFF REINIGER

DETERGENTE PER PLASTICA
Per tutte le superfici in materiale sintetico.



Cod. art. 1414
Formato ml.750



WOHMOBIL CARAVAN BOOT

DETERGENTE PER VETRORESINA
Concentrato fino a 50 litri.
Rimuove lo sporco più resistente, grasso, olio, macchie di pioggia e incrostazioni.



Cod. art. 1412
Formato Lt.1



MULTI POWER KRAFTREINIGER

DETERGENTE SGRASSANTE
Super sgrassante per superfici lavabili come finestre, porte, battiscopa, canaline per cavi, radiatori, pannelli, facciate di cucine e mobili, ringhiere e corrimano, tapparelle, vetri e superfici simili.



Cod. art. 1413
Formato ml.750



SGRASSA TUTTO CAPEC

DETERGENTE CONCENTRATO
Sgrassante non corrosivo, efficace per pulire tutte le superfici lavabili.
Utile in casa nei luoghi di lavoro in garage. Utilissimo per sporchi difficili.



Cod. art. 1425
Formato ml.750



SGRAS STOP DIXI

DETERGENTE SGRASSANTE
E' un prodotto sgrassante particolarmente indicato per la pulizia della cucina e dei piani cottura. Efficace sui piani in acciaio, sui laminati di legno e sulle piastrelle.



Cod. art. 10397
Formato ml.750



VETRO STOP DIXI

DETERGENTE PROFUMATO
E' un prodotto detergente specifico per la pulizia di vetri ad effetto antistatico.



Cod. art. 10396
Formato ml.750



ZEMENTSCHLEINER

DOPO POSA

Per la rimozione facile e rapida di veli di cemento, residui di calcestruzzo e malta, depositi di calcare, efflorescenze e impurità inorganiche.



Cod. art. 1426

Formato Lt.1



FHAM CONVERTITORE

CONVERTITORE DI RUGGINE

Pronto all'uso, trasforma la ruggine in un complesso metallo/organico perfettamente aderente alla superficie, formando una pellicola protettiva che permette la verniciatura del manufatto in ferro.



Cod. art. 1340 1342 1343

Formato ml.250 ml.750 Lt.4



DISOXIL

DISSODIANTE

Elimina la ruggine da tutte le superfici metalliche, elimina le incrostazioni calcaree e ferruginose dai servizi igienici, dalle vasche da bagno, da bottiglie, damigiane, serbatoi inox.



Cod. art. 1330 1331 1332

Formato ml.500 Lt.1 Lt.5



ACIDO CLORIDRICO 28/32

Soluzione al 28/32%, per uso professionale. Per la rimozione di calcare ostinato.



Cod. art. 8114 8115

Formato Lt.1 Lt.5



ACIDO TAMPONATO

Ottimo per la pulizia di pavimenti in gres, cotto e ceramica. Per disincrostare serpentine di caldaie e tubi



Cod. art. 8117

Formato Kg.5



CRESOLOX

Per igienizzare ambienti di ricovero animali. Canali di scolo fognature, cassonetti per rifiuti.



Cod. art. 1496

Formato Lt.1



DILUENTE SINTETICO



Cod. art.	0133	0132
Formato	Lt. 1	Lt.5



DILUENTE NITRO ANTINEBBIA



Cod. art.	0114	0113	0112	0111
Formato	ml.500	Lt.1	Lt.5	Lt.20



DILUENTE POLIURETANICO



Cod. art.	0143	0142
Formato	Lt. 1	Lt.5



DILUENTE POLIVALENTE



Cod. art.	0208
Formato	Lt. 1



ACQUA RAGIA PINO



Cod. art.	0155	0153	0152
Formato	ml.500	Lt. 1	Lt.5



ACQUA RAGIA INODORE PINO



Cod. art.	0165	0163	0162
Formato	ml.500	Lt. 1	Lt.5



ESSENZA DI TREMENTINA

Prodotto naturale ricavato dalla resina delle conifere con gradevole aroma. Viene utilizzata esclusivamente nelle belle arti.



Cod. art.	0952	0951
Formato	ml.500	Lt.1



AMMONIACA 28B

Altamente concentrata al 30-32% di gas (NH₃) Per la rimozione di macchie ostinate.



Cod. art.	0264
Formato	lt.1



ALCOOL ETILICO DENATURATO 94°

Può essere usato per sciogliere gommalacca, la colofonia e la canfora.

Può essere impiegato anche in tutti i lavori di pulizia tradizionalmente eseguiti con l'alcool etilico.



Cod. art.	0283	0282
Formato	Lt. 1	Lt.5

ALCOOL ETILICO DENATURATO 99°

Solvente specifico per la diluizione della gomma lacca.

E' un componente delle miscele di pulitura dei dipinti.



Cod. art.	0287	0288
Formato	Lt. 1	Lt.5

SOLUZIONE ALCOLICA 99,9%

Soluzione alcolica incolore particolarmente adatta per l'applicazione della gommalacca.

Utilizzata nel restauro di mobili antichi e di pregio.

Idonea per la diluizione di vernici a base alcolica e per le operazioni di pulizia e lavaggio.



Cod. art.	0280	0281
Formato	Lt. 1	Lt.5

PETROLIO LAMPANTE

Taglio petrolifero selezionato per la raffinazione molto accurata.

Liquido limpido e poco odoroso con evaporazione rallentata.

Viene utilizzato come sgrassante e pulente.



Cod. art.	0212
Formato	Lt. 1

ACETONE PURO

Trova impiego come solvente per grassi, oli, cere, resine, gomme, plastica, pitture, vernici, collanti a base gomma. Il prodotto risulta anche un ottimo sgrassante per superfici metalliche, legno, marmo, laminati, plastica, stoffe, ed altri materiali.



Cod. art.	0204	0202
Formato	Lt.1	Lt. 5

TRIALEX SMACCHIATORE

Sgrassatore industriale e smacchiatore tessuti, moquette, pellami, acciaio, metalli, ferro.

Solvente per la sgrassatura dei metalli, come liquido refrigerante e scambiatore di calore, intermedio di sintesi organiche, in farmaceutica come disinfettante e detergente.



Cod. art.	0238	0237
Formato	ml.500	Lt. 1

OLIO DI LINO COTTO

Puro al 100%

L'essiccazione avviene mediante l'azione dell'ossigeno dell'aria e non ad opera dei solventi che hanno la funzione di dare la giusta viscosità



Cod. art.	1700	1715	1702
Formato	ml.500	Lt.1	Lt.5

OLIO DI LINO CRUDO

Viene utilizzato normalmente per l'impregnazione tradizionale dei pavimenti in cotto, o di pietre in genere l'essiccazione è molto ritardata nel tempo.



Cod. art.	1710	1714	1712
Formato	ml.500	Lt.1	Lt.5

SODA CAUSTICA SCAGLIE

La soda caustica in scaglie Marten stasa gli scarichi domestici, svernica e non danneggia i metalli ferrosi.



Cod. art.	8123	8124
Formato	Kg.1	Kg.25

SODINA DETERGENTE

La Sodina Marten è un'eccellente, economico ed ecologico detergente multiuso. Non fa schiuma e non ha profumo. Prodotto ad alto potere sgrassante.



Cod. art.	8135	8136
Formato	Kg.1	Kg.25

SODIO BICARBONATO

Il Sodio Bicarbonato tecnico Marten è un prodotto ecologico, economico, sicuro e multiuso. Si può utilizzare sia in forma pura che diluito in soluzione acquosa.



Cod. art.	8137
Formato	Kg.1

ACIDO CITRICO MONOIDRATO

L'acido citrico è un prodotto biodegradabile. E' un anticalcare, disincrostante per lavatrici, lavastoviglie, decalcificante per macchine caffè espresso, ammorbidente per tessuti e brillantante per lavastoviglie.



Cod. art.	8139
Formato	Kg.1

ROHR FREI GEL

DISGORGANTE IN GEL

Potente detergente per sciogliere e abbattere ostruzioni ostinate ed eliminare gli odori sgradevoli. Grazie alla formula gel, il detergente viene distribuito lentamente e in modo uniforme negli scarichi e nelle tubazioni.



Cod. art.	0830
Formato	Lt.1

MARTEN STURATUTTO GRANULARE

Fortemente aggressivo studiato specificatamente per liberare le tubature otturate da depositi organici e inerti capelli, cartagienica, stracci, assorbenti igienici, ecc.



Cod. art.	1418
Formato	Gr.250

SAPONE LIQUIDO IGIENIZZANTE

Ideale per il lavaggio quotidiano delle mani.
Sapone igienizzante mani con studiato e formulato per usi frequenti, grazie al pH 6,5/7,5 non altera il normale equilibrio idrolipidico della cute.



Cod. art. 14551

Formato Lt.5



SAPONE LIQUIDO IGIENIZZANTE

SAPONE LIQUIDO NEUTRO

Sapone liquido adatto per la pulizia delle mani in particolare nel settore della ristorazione, alberghi, comunità, officine meccaniche, industrie. Il suo utilizzo garantisce una buona igiene delle mani ed un utilizzo frequente non provoca alcuna irritazione. Sapone lavamani gradevolmente profumato. biodegradabilità: oltre il 90%



Cod. art. 1455

Formato Lt.5



SAPONE LIQUIDO NEUTRO

CREMA LAVAMANI MARGHERITA

Prodotto universale idoneo sia in presenza di sporco grasso (olio, idrocarburi, petrolio) che secco (vernice, silicone, colla e smalto). Indicato anche per usi frequenti perché ha pH neutro ed è privo di solventi.



CREMA LAVAMANI MARGHERITA

Cod. art. 1457

Formato ml.2000

CREMA LAVAMANI BIANCA MARGHERITA

Speciale crema lavamani bianca in pasta con elevato potere sgrassante, ideale per lo sporco untuoso e intenso. E' la versione moderna della classica pasta Lavamani. Crema lavamani al profumo di lavanda.



CREMA LAVAMANI BIANCA MARGHERITA

Cod. art. 1452 1453

Formato ml.900 ml.4000

PASTA LAVAMANI MARGHERITA

Detergente in pasta abrasivo, utile per la rimozione dalle mani di sporco molto resistente e unto come quello procurato dal contatto con vernici, oli, colla, grassi, inchiostri, sostanze petrolifere ecc.

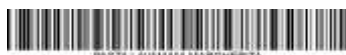

PASTA LAVAMANI MARGHERITA

Cod. art. 1450 1451

Formato Kg.1 Lt.4

ULTRA GRIM MULTIUSE

Salviette lavamani formato cm.38 x 25
Rimuove grasso, inchiostro, vernice, silicone
Ottima per schiuma PU



ULTRA GRIM MULTIUSE

Cod. art. 0985

Formato 100 salviette

GRASSO VIKY 54T

Grasso universale per la lubrificazione in condizioni di esercizio non gravose. Temperatura di esercizio: fino a + 65° C



Cod. art.	1429	1430	1432	1433
Formato	ml.75	ml.250	ml.500	ml.1000

GRASSO VIKY 50T

Grasso al Litio pregiato per parti metalliche, insolubile in acqua. Temperatura di esercizio: fino da -25°C a + 80°C



Cod. art.	1444	1445	1446
Formato	ml.75	ml.100	ml.400

SILICONE VIKY 101T

Grasso lubrificante per tubazioni plastiche. Conforme all'uso di acqua potabile. Conforme alla norma per il contatto con il cibo FDA - 21 - CFR - 178.3570 Temperatura d'esercizio: - 40° + 200°



Cod. art.	1435
Formato	ml.75

VASELLINA VIKY 51T

Scivolante, antiossidante, Insolubile in acqua. Conforme alla normativa di purezza farmaceutica DAB,BP,USP,PE. Conforme alla norma per il contatto con il cibo FDA - 21 - CFR - 178.3570



Cod. art.	1439	1440	1442
Formato	ml.75	gr.100	gr.400

ADDITIVO ADBLU

Soluzione acquosa pura al 32,5% studiata per ridurre le emissioni di ossido di azoto presenti negli scarichi di motori diesel.



Cod. art.	8150
Formato	Lt.10

CARTA ASCIUGATUTTO ECOCELL

Rotoli di carta ecologia, ricavata da carta da macero, caratterizzati dal colore naturale, privo di sbiancanti. K800 goffrato da 2 Kg



Cod. art.	1465
Confezione	2 rotoli

SACCO PATTUMIERA ANTIGOCCIA 140

- ✓ Misura 90 x 120
- ✓ Roll 6 buste
- ✓ 140 litri
- ✓ 80 micron
- ✓ Nero



Cod. art.

6934

SACCO PATTUMIERA - DIFFERENZIATA

- ✓ Misura 90 x 120
- ✓ Roll 7 buste
- ✓ 140 litri
- ✓ 80 micron
- ✓ Trasparente Ambra



Cod. art.

6935

SACCO PATTUMIERA ANTIGOCCIA 110

- ✓ Misura 72 x 110
- ✓ Roll 10 buste
- ✓ 110 litri
- ✓ 30 micron
- ✓ Nero



Cod. art.

6931

SACCO PATTUMIERA ANTIGOCCIA 110

- ✓ Misura 72 x 110
- ✓ Roll 10 buste
- ✓ 110 litri
- ✓ 50 micron
- ✓ Nero



Cod. art.

6932

SACCO PATTUMIERA ANTIGOCCIA 35

- ✓ Misura 50 x 60
- ✓ Roll 20 buste
- ✓ 35 litri
- ✓ 16 micron
- ✓ Nero



Cod. art.

6930

SACCO PER RIFIUTI EDILI

- ✓ Misura 40 x 70
- ✓ Roll 15 buste
- ✓ 35 litri
- ✓ 120 micron
- ✓ Ambra



Cod. art.

6933

SALI PER DEUMIFICATORI



Cod. art. **1297** **1297 B**
 formato kg.500 Kg.2,5

DEUMIDIFICATORE ABSODRY



Cod. art. **1291** **1292**
 formato Absodry Ricarica

ARIASANA ASSORBUMIDITA'

Completo di 1 ricariche da 450 gr.



Cod. art. **1294**
 formato Kit Mini



ARIASANA RICARICA

Ricarica per assorbire umidità



Cod. art. **1299**
 formato Gr.450x5



ARIASANA AERO 360 MAXI



Cod. art. **1293**
 formato Gr.450x3 Inodore

ARIASANA AERO 360 MINI



Cod. art. **12931**
 formato Gr.450x2 Lavanda

CARTA IGIENICA MAXI ROLL

I rotoloni di carta igienica sono la soluzione ideale per ambienti pubblici o lavorativi con alto afflusso di persone.



Cod. art. **1462**
 Confezione 12 rotoli

CARTA ASCIUGAMANI Z

Asciugamani di carta piegati a Z monouso (anche per dispenser a C) - 25 pacchetti da 150 salviette.



Cod. art. **1463**
 Confezione 25 pezzi



Linea Spray

- Acrilici tinte ral
- Fuorescenti tinte ral
- Metallizzati tinte ral
- Cromature
- Ori - Argento - Rameo
- Micaceo tinte ral
- Lubrificanti
- Protettivi
- Pulitori
- Fondi - Aggrappanti
- Colle
- Traccianti Marker
- Ricarica aerosol



VERNICE FERROMICACEO



VERNICE FERROMICACEO SPRAY



Cod. art. 1284 FA FERRO ANTICO	Cod. art. 1284 GF GRIGIO FORGIA	Cod. art. 1284 GC GRIGIO CHIARO
-----------------------------------	------------------------------------	------------------------------------



1296

Cod. art.

1296

Formato

400 ml.



VERNICE FLUORESCENTE



VERNICE FLUORESCENTE SPRAY



Cod.1282 RO ROSA	Cod.1282 R ROSSO	Cod.1282 G GIALLO	Cod.1282 A ARANCIO	Cod.1282 B BLU	Cod.1282 V VERDE
---------------------	---------------------	----------------------	-----------------------	-------------------	---------------------

ORI – ARGENTO & CROMATURE



VERNICE ORI - ARGENTO E CROMATURE SPRAY



Cod. art. 1278 ARGENTO	Cod. art. 1272 ORO PALLIDO	Cod. art. 1272 ORO RICCO	Cod. art. 1272 RAME	Cod. art. 1232 ORO CROMO	Cod. art. 1234 ARGENTO CROMO
---------------------------	-------------------------------	-----------------------------	------------------------	-----------------------------	---------------------------------

VERNICE METALLIZZATA SPRAY



VERNICE METALLIZZATA SPRAY



Cod. 1283B BLU	Cod.1283 G GIALLO	Cod.1283 V VERDE	Cod.1283 R ROSSO	Cod.1283 A ARGENTO	Cod.1283 N NERO	Cod.1283 VIO VIOLA
-------------------	----------------------	---------------------	---------------------	-----------------------	--------------------	-----------------------

ACRILICO SPRAY LUCIDO



Linea Spray Tecnici

ACRILICO SPRAY OPACO



Cod.1270 BO
BIANCO

Cod.1270 NO
NERO

Cod.1270 TO
TRASPARENTE

Cod.1270 VM
VERDE MILITARE



LUBRIFICANTI

VASELLINA OLIO PURISSIMO

Olio protettivo ad elevato grado di purezza. La vaselina spray è un lubrificante protettivo che protegge i metalli come alluminio, rame, ottone, cromo, acciaio, ecc. in modo affidabile e sicuro da acidi, basi e Sali. Idrorepellente, resiste agli agenti atmosferici. Indicato per lubrificare meccanismi delicati, antenne, contatti batteria, serrature, guide per tendaggi. La sua speciale formula esercita inoltre un potere protettivo duraturo



Cod. art. **8311**

Formato 400 ml.



GRASSO MULTIUSO

Spray tecnico lubrificante ed anticorrosivo ad elevata viscosità per lubrificare parti meccaniche nel tempo, composto da grassi saponificati di elevata qualità. Ottima stabilità meccanica e termica, eccellente ancoraggio alle superfici, idrorepellente. Resiste ad ambienti salini, alle soluzioni basiche ed acide deboli, agli agenti atmosferici. Ideale per la lubrificazione di cuscinetti, bronzine, mozzi, snodi perni, guide ed in generale nel settore degli autoveicoli, macchine agricole ed industriali.



Cod. art. **8319**

Formato 400 ml.



SILICONE PROTETTIVO

Soluzione a base di puro olio di silicone che possiede proprietà antiadesive distaccanti e lubrificanti sui più svariati materiali, in particolare le superfici sintetiche, plastiche e gomma. Inoltre conferisce una buona idrorepellenza sui materiali trattati prevenendo l'accumulo di cariche elettrostatiche. E' efficace come lucidante e protettivo sulle parti plastiche e protegge le guarnizioni da screpolature aumentandone la tenuta e la durata



Cod. art. **8320**

Formato 400 ml.



SVITO LESTO SBLOCCANTE

Prodotto lubrificante e protettivo multifunzionale che penetra in profondità e sblocca incrostazioni e ruggine, lubrifica, arresta e previene le ossidazioni, rimuove l'umidità, impedisce le dispersioni di corrente. Ideale per: serrature, attrezzi da giardino, ingranaggi, pedali, utensili, ferramenta, attrezzi da palestra



Cod. art. **1217**

Formato 400 ml.



LUBRIFICANTI

SVITA T1 MULTIFUNZIONE

Prodotto lubrificante e protettivo multifunzionale che penetra in profondità e sblocca incrostazioni e ruggine, lubrifica, arresta e previene le ossidazioni, rimuove l'umidità, prodotto ad alte prestazioni.



Cod. art. **1218**

Formato 400 ml.



SVITA DEGRIPPANTE

Prodotto ad elevato potere penetrante studiato per risolvere istantaneamente e simultaneamente problemi e situazioni di emergenza in casa, nell'auto, nel fai da te e nel lavoro. Penetra in profondità e sblocca incrostazioni e ruggine, lubrifica, arresta e previene le ossidazioni, rimuove l'umidità e impedisce le dispersioni di corrente.



Cod. art. **1216**

Formato 200 ml.



GRASSO MULTIUSO PTFE

Ideale per la lubrificazione e la protezione di elementi meccanici sottoposti a periodo di lavoro continuo in condizioni normali o standard di temperatura e velocità di movimento. Agisce a temperature a + 250°C



Cod. art.

8317

Formato

400 ml.



GRASSO NAUTICO AL LITIO

Prodotto specifico per proteggere e lubrificare parti meccaniche posizionate in condizioni ambientali particolarmente aggressive. Ideale per la lubrificazione e protezione di componenti nautici esposti a salsedine come timonerie, leveraggi, snodi, cavi, rulli, eliche, flap, verricelli.



Cod. art.

8318

Formato

400 ml.



OLIO PER ARMI

Protettivo, anticorrosivo, lubrificante per armi. È un olio finissimo con elevata proprietà di penetrazione e pulizia. È indispensabile per la manutenzione di tutti i tipi di armi. Forma una barriera protettiva contro l'umidità, l'acqua e le sostanze corrosive delle polveri da sparo.



Cod. art.

1215

Formato

200 ml.



PROTETTIVI

RUGGINE STOP CAPEC

PASSIVANTE PER FERRI D'ARMATURA

Specifico per superfici metalliche. Isola i ferri di armatura dal contatto diretto con agenti atmosferici rendendoli impermeabili. Di seguito si può procedere con l'applicazione delle malte di ripristino.

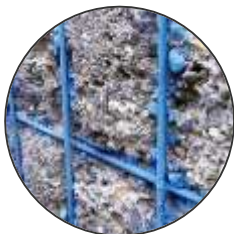

Cod. art. **1256**

Formato 500 ml.



PLASTIVEL PROTETTIVO

Plastivel® ha potere impermeabilizzante, idrorepellente, antiossidante, antistatico. Il film protettivo, inoltre, è flessibile senza pericolo di rottura, non ingiallisce, non subisce l'attacco dei raggi UV né di acidi, alcali, oli minerali e prodotti chimici per la pulizia della casa.



Cod. art. **0708**

Formato 400 ml.



VERNICE ALTE TEMPERATURE

Resistente alle intemperie e alla luce. Non ingiallisce. Adatto per marmitte, collettori, radiatori, termosifoni, canne fumarie, stufe, forni.

Bombola da 400 ml.



Cod. art.

1222
NERO

1222BI
Bianco

1222AL
Alluminio

1222TR
Trasparente

1223
Rosso freni



RINNOVA PARAURTI

Ideale per verniciare o rinnovare fascioni, paraurti e spoiler o parti in plastica di roulotte, caravan o moto oppure tubazioni e laminati plastici.

Bombola da 400 ml.



Cod. art.

1244NO
Nero opaco

1244A
Antracite



ALLUMINIO RUOTE FIAT 690

Smalto acrilico speciale ad essiccazione rapida con elevata resistenza agli agenti atmosferici per ritoccare o verniciare cerchioni auto in acciaio o in lega.

Bombola da 400 ml.



Cod. art.

1223AR



PROTETTIVI

BI TECH GUAINA

GUAINA PROTETTIVA NERA

Sigillante - rivestimento protettivo impermeabilizzante a base solvente, formulato con bitume, resine elastomeriche selezionate e speciali additivi.



BI TECH GUAINA

Cod. art. **8316**

Formato 500 ml.



ELASTEK GUAINA

GUAINA IMPERMEABILIZZANTE GRIGIA



ELASTEK GUAINA

Cod. art. **8315**

Formato 500 ml.



ACCIAIO INOX

Smalto per utilizzo professionale e hobbistico. Contiene polvere di acciaio per offrire una finitura professionale e altamente protettiva anche nelle condizioni più gravose. Per interni ed esterni. Rapida essiccazione.



ACCIAIO INOX SPRAY



Cod. art.

1289

Formato

400 ml.



ZINCANTE

Vernice zincante ad alto spessore. Lo zinco contenuto forma un rivestimento metallico altamente resistente alla corrosione degli agenti atmosferici e salsedine. Sovra-vernicabile. Percentuale di zinco su residuo secco 0,8%



ZINCANTE SPRAY



Cod. art.

1288

Formato

400 ml.



ZINCANTE 98

Vernice zincante ad alto spessore. Lo zinco contenuto forma un rivestimento metallico altamente resistente alla corrosione degli agenti atmosferici e salsedine. Sovra-vernicabile. Percentuale di zinco su residuo secco 10%



ZINCANTE 98 SPRAY



Cod. art.

1290

Formato

400 ml.



PULITORI

PULITORE IGIENIZZANTE

AUTOVEICOLI E CLIMATIZZATORI

Garantisce una perfetta azione pulente e igienizzante contro i principali batteri contenuti in ambienti e impianti con presenza di aria condizionata.

Ha una durata da un minimo di 10 fino a 45 giorni.

Particolarmente indicato per uso civile.



Cod. art. **1214**

Formato 400 ml.



PULITORE CONTATTI ELETTRICI

Indispensabile per riattivare e lubrificare circuiti elettrici e meccanismi vari. Ideale per l'auto, la casa, il lavoro

La moto, il tempo libero. Garantisce efficacia istantanea nel ripristinare la conducibilità elettrica, espellere l'umidità

Nei circuiti bagnati e nello sbloccare meccanismi intaccati da ossidazioni, ruggine, ecc.



Cod. art. **1213**

Formato 400 ml.



ARIA PULITORE

Miscela di propellenti ad alta pressione per eliminare velocemente la polvere depositata sulle superfici meno accessibili. E' indicato per la pulizia di lenti, obiettivi, computer, orologeria e meccanica in genere.



Cod. art.

1221

Formato

400 ml.



SILICONE STOP

Miscela di solventi adatti per rimuovere le eccedenze e gli sfridi di silicone.

Il prodotto agisce rapidamente in presenza di silicone fresco, mentre sul silicone asciutto ha un'azione più lenta.



Cod. art.

8323

Formato

400 ml.



STICKER STOP

Miscela di solventi adatti per rimuovere residui di colle ed etichette. Il prodotto agisce rapidamente in assenza di barriere, quali ad esempio carta e plastica degli adesivi. Non è aggressivo sulle superfici e non opacizza.



Cod. art.

8322

Formato

400 ml.



FONDI

ANCORANTE LEGHE LEGGERE

Fondo aggrappante specifico per parti in plastica. Ideali per superfici dove le vernici hanno scarsa aderenza quali policarbonato, polipropilene e similari. Rapida essiccazione. Resistente alle intemperie e alla luce. Sovra-vernicabile.

TRASPARENTE



Cod. art. **1253**

Formato 400 ml.



FONDO ANTIRUGGINE

Fondo protettivo. Se correttamente applicato, previene la formazione delle ruggine sulle superfici di metallo. Sovra-vernicabile dopo completa essiccazione. Le resine acriliche contenute consentono l'utilizzo per interni ed esterni, garantendo la resistenza nel tempo agli agenti atmosferici.



Cod. art. **1258**

Formato 400 ml.



STUCCO ANTIRUGGINE

Fondo riempitivo acrilico, consente di stuccare e uniformare superfici con piccoli graffi e imperfezioni. Per interni ed esterni. Rapida essiccazione. Sovra-vernicabile.

Adatto per carrozzeria o superfici in metallo. Se necessario, prima di riverniciare, carteggiare con carta abrasiva molto fine.



Cod. art. **1252**

Formato 400 ml.



NO RUST PRIMER

FONDO ANTIRUGGINE BIANCO

Previene la formazione della ruggine sulle superfici di metallo. Sovra-vernicabile dopo completa essiccazione. Le resine acriliche contenute consentono l'utilizzo per interni ed esterni.



Cod. art. **1257**

Formato 400 ml.



COPRIMACCHIA SPRAY

Fondo acrilico bianco opaco ad elevata copertura. Copre e scherma le macchie sulle pareti in modo da evitare il riaffiorare dopo la verniciatura con idropitture e pitture murali.



Cod. art. 1251

Formato 400 ml.



COLLA REMOVIBILE

Ideale per il fissaggio a breve termine di materiali leggeri quando si realizzano layout, mostre o composizioni fotografiche. Si può utilizzare per realizzare cartelle, raccolte fotografiche.



Cod. art. 1219

Formato 400 ml.



FLECKEN DECKER

ISOLANTE BIANCO SPRAY

Isola le macchie di fuliggine, fuoco, grasso, catrame, nicotina. Impedirà la successiva penetrazione di impurità.



Cod. art. 1250

Formato 400 ml.



COLLA PERMANENTE

Per l'incollaggio di carta, cartone, fotografie, poster, riproduzioni, feltro, tessuti, sughero, schiuma di polistirolo, schiuma di poliuretano, fogli di metallo ecc.



Cod. art. 1220

Formato 400 ml.



STAIN COVER SPRAY

Fondo acrilico bianco opaco ad elevata copertura. Copre e scherma le macchie sulle pareti in modo da evitare il riaffiorare di macchie di fumo, fuliggine, sporco, unto.



Cod. art. 1255

Formato 500 ml.



MARKER PAINT SPRAY

Prodotto studiato e creato per effettuare operazioni di tracciatura e marcatura su superfici in cemento, asfalto, legno laterizi in genere etc.



Cod. art. 1285

Formato 500 ml.



Rosso



Giallo



Arancio



Articoli per la Casa

- Guide per tende
- Ganci per tende
- Ganci per quadri
- Chiodini
- Paracolpi
- Calamite
- Ventosine
- Scivoli per mobili
- Feltrini
- Porta abiti
- Ganci per cucina
- Fermatovaglie
- Cintini per tapparella
- Ritocchi per sanitari
- Accessori per bagno
- Sottoporta
- Guarnizioni per porta
- Portachiavi
- Linea Pronty

Accessori per tende

GUIDA TENDA ONLY ONE BIANCA

In acciaio mm.10, applicabili a pressione con dentino, con ventosa o rampino

In confezione self service da 2 pezzi

ONLY ONE
L'ASTINA COL DENTINO



GUIDA TENDA ONLY ONE BIANCA

Cod. art.	3720	3721	3722
Formato	cm.27/36	cm.37/63	cm.61/110

GUIDA TENDA TONDY BIANCA

Svitare l'astina non più di 1,5 cm

In confezione self service da 2 pezzi



GUIDA TENDA TONDY BIANCA

Cod. art.	3730	3731	3732
Formato	cm.27/36	cm.36/60	cm.63/110

GUIDA TENDA ONLY ONE CROMO

In acciaio mm.10, applicabili a pressione con dentino, con ventosa o rampino

In confezione self service da 2 pezzi

ONLY ONE
L'ASTINA COL DENTINO

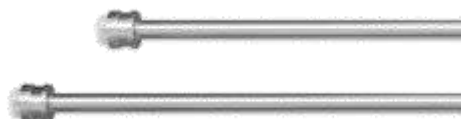

GUIDA TENDA ONLY ONE CROMO

Cod. art.	3700	3701	3702
Formato	cm.27/36	cm.37/63	cm.61/110

GUIDA TENDA TONDY CROMO

Svitare l'astina non più di 1,5 cm

In confezione self service da 2 pezzi



GUIDA TENDA TONDY CROMO

Cod. art.	3733	3734	3735
Formato	cm.27/36	cm.36/60	cm.63/110

GUIDA TENDA ONLY ONE ORO

In acciaio mm.10, applicabili a pressione con dentino, con ventosa o rampino

In confezione self service da 2 pezzi

ONLY ONE
L'ASTINA COL DENTINO



GUIDA TENDA ONLY ONE ORO

Cod. art.	3710	3711	3712
Formato	cm.27/36	cm.37/63	cm.61/110

GUIDA TENDA TONDY ORO

Svitare l'astina non più di 1,5 cm

In confezione self service da 2 pezzi



GUIDA TENDA TONDY ORO

Cod. art.	3736	3737	3738
Formato	cm.27/36	cm.36/60	cm.63/110

GUIDA TENDA PIATY

In acciaio, con vite di regolazione

In confezione self service da 1 pezzo



GUIDA TENDA PIATY

Cod. art.	3740	3741	3742	3743	3744
Formato	cm.27/40	cm.39/60	cm.55/90	cm.87/150	cm.150/240

Accessori per tende

GANCIO PER BRIS-BRIS IN PLASTICA

Con rampino in acciaio cromato, mm.29x16, autoadesivi
In blister da 4 pezzi



Cod. art.	3924	3923
Colore	Marrone	Bianco

GANCIO PER BRIS-BRIS IN METALLO

Adatti per infissi in alluminio, mm.25x20, larghezza mm.7
In scatola sfuso



Cod. art.	3919	3920
Colore	Bianco	Ox

GANCIO PER BRIS-BRIS TONDO IN METALLO

Interamente in metallo, Ø mm.25, con biadesivo
In blister self da 2 pezzi



Cod. art.	98504	98505	98506
Colore	Oro	Bianco	Cromo

GANCIO PER BRIS-BRIS TONDO IN METALLO SFUSO

Interamente in metallo, Ø mm.25, con biadesivo
In scatola da 100 pezzi



Cod. art.	98508	98507	98509
Colore	Oro	Bianco	Cromo

GANCIO PER TENDA 30

in metallo, mm.30, completi di viti e tasselli
In blister self da 2 pezzi



Cod. art.	98480	98482	98481
Colore	Bronzo	Oro	Cromo

GANCIO PER TENDA 37

in metallo, mm.37, completi di viti e tasselli
In blister self da 2 pezzi



Cod. art.	98483	98485	98484
Colore	Bronzo	Oro	Cromo

GANCIO PER TENDA 48

in metallo, mm.48, completi di viti e tasselli
In blister self da 2 pezzi



Cod. art.	98490	98489	98491
Colore	Bronzo	Oro	Cromo

PRONTY

Con la tua creatività la Linea Pronty ti permette di creare in poco tempo e senza costi eccessivi molteplici soluzioni per la casa.

La qualità del prodotto assicura nel tempo l'inalterabilità delle finiture anche in ambienti come cucine e bagni.

Si possono realizzare:

PORTAMESTOLI

GUIDE PORTA TENDE

PORTA ASCIUGAMANO

PORTA ROTOLO DA CUCINA

FERMA PASSATOIA



FaiDaTe
Creativo



TUBO ALLUMINIO LINEA PRONTY

Cod. art.	3799 O	3799 A	3799 S
Colore	Oro	Argento	Satinato



TUBO IN ALLUMINIO MT.1,98



TUBO ALLUMINIO LINEA PRONTY

Cod. art.	3799 R	3799 F	3799 OT
Colore	Rame	Ferro battuto	Ottone



MENSOLINA LUNGA
in acciaio **ORO**
cm.4 con vite e tassello
In blister self da 2 pezzi



Cod. art.

3866



3866

MENSOLINA LUNGA
in acciaio **ARGENTO**
cm.4 con vite e tassello
In blister self da 2 pezzi



Cod. art.

3865



3865

MENSOLINA LUNGA
in acciaio **OTTONE**
cm.4 con vite e tassello
In blister self da 2 pezzi



Cod. art.

3781 OT



3781 OT

MENSOLINA LUNGA
in acciaio **RAMATO**
cm.4 con vite e tassello
In blister self da 2 pezzi



Cod. art.

3781 R



3781R

MENSOLINA LUNGA
in acciaio **FERRO BATTUTO**
cm.4 con vite e tassello
In blister self da 2 pezzi



Cod. art.

3781 F



3781F

MENSOLINA MEDIA
in acciaio **ORO**
cm.3 con vite e tassello
In blister self da 2 pezzi



Cod. art.

3864



3864

MENSOLINA MEDIA
in acciaio **ARGENTO**
cm.3 con vite e tassello
In blister self da 2 pezzi



Cod. art.

3863



3863

MENSOLINA MEDIA
in acciaio **RAMATO**
cm.3 con vite e tassello
In blister self da 2 pezzi



Cod. art.

3787 R



3787R

MENSOLINA MEDIA
in acciaio **OTTONE**
cm.3 con vite e tassello
In blister self da 2 pezzi



Cod. art.

3787 OT



3787OT

SUPPORTO LATERALE
in acciaio **ORO**
Ø 12 mm
In blister self da 2 pezzi



Cod. art.

3872



3872

SUPPORTO LATERALE
in acciaio **ARGENTO**
Ø 12 mm
In blister self da 2 pezzi



Cod. art.

3871



3871

SUPPORTO LATERALE
in acciaio **OTTONE**
Ø 12
In blister self da 2 pezzi



Cod. art.

3778 OT



3778OT

MENSOLINA CORTA
in acciaio **ORO**
cm.2,5 con vite e tassello
In blister self da 2 pezzi



Cod. art.

3862



3862

MENSOLINA CORTA
in acciaio **ARGENTO**
cm.2,5 con vite e tassello
In blister self da 2 pezzi



Cod. art.

3861



3861

MENSOLINA CORTA
in acciaio **OTTONE**
cm.2,5 con vite e tassello
In blister self da 2 pezzi



Cod. art.

3862 OT



3862OT

MENSOLINA CORTA
in acciaio **RAMATO**
cm.2,5 con vite e tassello
In blister self da 2 pezzi



Cod. art.

3862 R



3862R

MENSOLINA CORTA
in acciaio **FERRO BATTUTO**
cm.2,5 con vite e tassello
In blister self da 2 pezzi



Cod. art.

3862 FB



3862FB

BASSETTA PICCOLA
in acciaio **ORO**
Ø 25 mm con biadesivo
In blister self da 2 pezzi



Cod. art.

3884



3884

BASSETTA GRANDE
in acciaio **ORO**
Ø 35 mm con biadesivo
In blister self da 2 pezzi



Cod. art.

3888



3888

BASSETTA GRANDE
in acciaio **ARGENTO**
Ø 35 mm con biadesivo
In blister self da 2 pezzi



Cod. art.

3889



3889

BASSETTA PICCOLA
in acciaio **ARGENTO**
Ø 25 mm con biadesivo
In blister self da 2 pezzi



Cod. art.

3885



3885

BASSETTA GRANDE
in acciaio **RAMATO**
Ø 35 mm con biadesivo
In blister self da 2 pezzi



Cod. art.

3798 R



3798R

BASSETTA GRANDE
in acciaio **FERRO BATTUTO**
Ø 35 mm con biadesivo
In blister self da 2 pezzi



Cod. art.

3798 F



3798F

BASSETTA GRANDE
in acciaio **OTTONE**
Ø 35 mm con biadesivo
In blister self da 2 pezzi

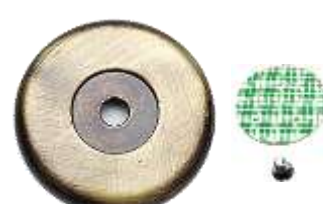

Cod. art.

3798 OT



3798OT

FINALE SFERA

in acciaio **ORO**
In blister self da 2 pezzi



Cod. art.

3876



FINALE SFERA

in acciaio **ARGENTO**
In blister self da 2 pezzi



Cod. art.

3875



FINALE SFERA

in acciaio **OTTONE**
In blister self da 2 pezzi



Cod. art.

3792 OT



FINALE SFERA

in acciaio **RAMATO**
In blister self da 2 pezzi



Cod. art.

3792 R



FINALE SFERA

in acciaio **FERRO BATTUTO**
In blister self da 2 pezzi



Cod. art.

3792 F



FINALE PIATTO

in acciaio **ORO**
In blister self da 2 pezzi



Cod. art.

3874



FINALE PIATTO

in acciaio **ARGENTO**
In blister self da 2 pezzi



Cod. art.

3873



FINALE PIATTO

in acciaio **RAMATO**
In blister self da 2 pezzi



Cod. art.

3873 R



FINALE PIATTO

in acciaio **FERRO BATTUTO**
In blister self da 2 pezzi



Cod. art.

3873 F



FINALE PIATTO

in acciaio **OTTONE**
In blister self da 2 pezzi



Cod. art.

3873 OT



GANCIO MESTOLO

in acciaio **ORO**
In blister self da 6 pezzi



Cod. art.

3878



GANCIO MESTOLO

in acciaio **ARGENTO**
In blister self da 6 pezzi



Cod. art.

3877



GANCIO A «S»

in acciaio 52 mm

ORO

In blister self da 4 pezzi



Cod. art.

3880



GANCIO A «S»

in acciaio 52 mm

BIANCO

In blister self da 4 pezzi



Cod. art.

3881



GANCIO A «S»

in acciaio 52 mm

SATINATO

In blister self da 4 pezzi



Cod. art.

3879



GANCIO A «S»

in acciaio 52 mm

FERRO BATTUTO

In blister self da 4 pezzi



Cod. art.

3783 F



GANCIO A «S»

in acciaio 52 mm

RAME

In blister self da 4 pezzi



Cod. art.

3783 R



GANCIO A «S»

in acciaio 52 mm

OTTONE

In blister self da 4 pezzi



Cod. art.

3783 OT



Anello TENDA

in acciaio Ø 12 mm

ORO

In blister self service da 6 pezzi



Cod. art.

3890



Anello TENDA

in acciaio Ø 12 mm

ARGENTO

In blister self service da 6 pezzi



Cod. art.

3891



Anello TENDA

in acciaio Ø 12 mm

FERRO BATTUTO

In blister self service da 6 pezzi



Cod. art.

3785 F



Anello TENDA

in acciaio Ø 12 mm

RAMATO

In blister self service da 6 pezzi



Cod. art.

3785 R



Anello TENDA

in acciaio Ø 12 mm

OTTONE

In blister self service da 6 pezzi



Cod. art.

3785 OT



Ganci per quadri

GANCI GIGLIO PICCOLO ARGENTO

In metallo, mm.33 completi di chiodino
In blister self da 5 pezzi



Cod. art.

3665

GANCI GIGLIO PICCOLO ORO

In metallo, mm.33 completi di chiodino
In blister self da 5 pezzi



Cod. art.

3664

GANCI GIGLIO PICCOLO BRONZO

In metallo, mm.33 completi di chiodino
In blister self da 5 pezzi



Cod. art.

3666



GANCIO GIGLIO PICCOLO

GANCI GIGLIO GRANDE ARGENTO

In metallo, mm.47 completi di chiodino
In blister self da 3 pezzi



Cod. art.

3668

GANCI GIGLIO GRANDE ORO

In metallo, mm.47 completi di chiodino
In blister self da 3 pezzi



Cod. art.

3667

GANCI GIGLIO GRANDE BRONZO

In metallo, mm.47 completi di chiodino
In blister self da 3 pezzi



Cod. art.

3669



GANCIO GIGLIO GRANDE

GANCI POLO ORO

In metallo, completi di chiodino
In blister self da 4 pezzi



Cod. art.

3672



3672

GANCIO PERLINA ORO

In metallo, completi di chiodino
In blister self da 5 pezzi



Cod. art.

98502



98502

GANCI TIPO BLITZ

in plastica trasparente, completi di chiodini
e applicatore
In blister self da 20 pezzi



Cod. art.

3676



3676

ATTACCAGLIA PER QUADRI

In PVC con biadesivo
In blister self da 12 pezzi



Cod. art.

3686



3686

GANCI RAMPINO ORO

In metallo, completi di tassello
In blister self da 10 pezzi



Cod. art.

3678



3678

GANCI RAMPINO ORO

In metallo, completi di tassello
In scatola da 10 pezzi



Cod. art.

97312



97312

Ganci per quadri

GANCIO GOCCIA ORO

In metallo, completi di chiodino
In blister self da 3 pezzi



Cod. art.

3671

GANCIO GOCCIA BIANCA

In metallo, completi di chiodino
In blister self da 3 pezzi



Cod. art.

3670

GANCIO GOCCIA NERA

In metallo, completi di chiodino
In blister self da 3 pezzi



Cod. art.

91153



GANCIO A GOCCIA PER QUADRI

GANCIO GOCCIA ARGENTO

In metallo, completi di chiodino
In blister self da 3 pezzi



Cod. art.

91154



91154

CHIODINO PER QUADRI

In acciaio
In blister self da 80 pezzi



Cod. art.

3685



3685

CHIODINO PER QUADRI

In acciaio
In scatola da 100 pezzi



Cod. art.

3510



3510

CHIODINO TESTA OTTONATA

In acciaio mm.20
In blister self da 20 pezzi



Cod. art.

3679

CHIODINO TESTA OTTONATA

In acciaio mm.25
In blister self da 18 pezzi



Cod. art.

3680

CHIODINO TESTA OTTONATA

In acciaio mm.30
In blister self da 15 pezzi



Cod. art.

3681



CHIODINO TESTA OTTONATA IN BLISTER

CHIODINO TESTA OTTONATA

In acciaio mm.20
In scatola da 18 pezzi



Cod. art.

4315

CHIODINO TESTA OTTONATA

In acciaio mm.25
In scatola service da 18 pezzi



Cod. art.

4316

CHIODINO TESTA OTTONATA

In acciaio mm.30
In scatola service da 18 pezzi



Cod. art.

4317



CHIODINO TESTA OTTONATA IN SCATOLA

Ganci per quadri

GANCI X N°0

In acciaio
In blister self da 10 pezzi



Cod. art.

3682

GANCI X N°2

In acciaio
In blister self da 10 pezzi



Cod. art.

3683

GANCI X N°3

In acciaio
In blister self da 10 pezzi



Cod. art.

3684



GANCIO X PER QUADRI IN BLISTER

GANCI X N°0

In acciaio
In scatola self da 10 pezzi



Cod. art.

3530

GANCI X N°1

In acciaio
In scatola self da 10 pezzi



Cod. art.

3531

GANCI X N°2

In acciaio
In scatola self da 10 pezzi



Cod. art.

3532



GANCIO X PER QUADRI IN SCATOLA

ATTACAGLIA FISSA

In blister self da 16 pezzi



Cod. art.

3689

N°1 - H mm29

Cod. art.

3690

N°2 - H mm34



ATTACAGLIA FISSA PER QUADRI

PUNTINE DA DISEGNO

In acciaio ASSORTITE
In blister self da 15 pezzi



Cod. art.

3946 B



3946B

PUNTINE DA DISEGNO

In acciaio BIANCHE
In blister self da 15 pezzi



Cod. art.

3947 B



3947B

ATTACAGLIA SNODATA

In blister self da 30 pezzi

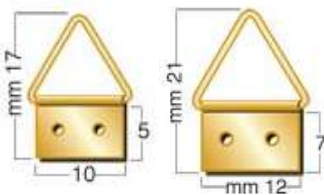

Cod. art.

3687

N°1 - H mm17

Cod. art.

3688

N°2 - H mm21



ATTACAGLIA SNODATA PER QUADRI

PUNTINE DA DISEGNO

In acciaio
In scatola da 70 pezzi



PUNTINE DA DISEGNO IN SCATOLA

Cod. art.

Colore

3949

Rosso

3949 V

Verde

3949 G

Giallo

3947

Bianco

3949 B

Blu

3948

Nero

Paracolpi

FERMAPORTE BIRILLO

In gomma Bianco
In blister self da 2 pezzi



Cod. art.

3931 B

FERMAPORTE BIRILLO

In gomma Trasparente
In blister self da 2 pezzi



Cod. art.

3933 B

FERMAPORTE BIRILLO

In gomma Marrone
In blister self da 2 pezzi



Cod. art.

3932 B



FERMAPORTE A BIRILLO IN BLISTER

FERMAPORTE BIRILLO

In gomma Bianco
In scatola da 50 pezzi



Cod. art.

3931

FERMAPORTE BIRILLO

In gomma Trasparente
In scatola da 50 pezzi



Cod. art.

3933

FERMAPORTE BIRILLO

In gomma Marrone
In scatola da 50 pezzi



Cod. art.

3932



FERMAPORTE A BIRILLO IN SCATOLA

PARASPIGOLO ANGOLARE

In gomma Trasparente cm.3x3
In blister self da 2 pezzi



Cod. art.

39551B



39551B

PARASPIGOLO ANGOLARE

In gomma Trasparente cm.3x3
In scatola



Cod. art.

39551



39551

CINTURINO SALVA MANIGLIA

In gomma Trasparente
In scatola



Cod. art.

3910



3910

PARACOLPO PER MANIGLIE

In gomma a 2 anelli
In blister self da 2 pezzi



Cod. art.

3909B



3909B

PARACOLPO PER MANIGLIE

In gomma a 2 anelli
In scatola



Cod. art.

3909



3909

PARACOLPO PER MANIGLIE

In gomma a 1 anello
In scatola



Cod. art.

39091



39091

VENTOSINA PER VETRI

In gomma gambo pieno mm.25
In blister self da 2 pezzi



Cod. art.



5980B

CALAMITA IN NEODIMIO

In acciaio mm.20 x 3
Attrazione ca. 4,60 kg.



Cod. art.



29862

SOTTOSEDIA BIANCHI



Cod. art.



3905

VENTOSINA PER VETRI

In gomma gambo vuoto mm.20
In blister self da 2 pezzi



Cod. art.



5983B

CALAMITA IN NEODIMIO

In acciaio mm.15 x 2
Attrazione ca. 1,70 kg.



Cod. art.



29861

SOTTOSEDIA NERI



Cod. art.



3906

FERMAPORTE TRAPEZIO

In gomma BIANCO
In blister self da 4 pezzi



Cod. art.



3907B

CALAMITA IN NEODIMIO

In acciaio mm.15 x 6
Attrazione ca. 5 kg.



Cod. art.



29860

SCIVOLO IN TEFLON



SCIVOLO IN TEFLON

31254

31252

31251

31250

Ø 25

Ø 40

Ø 50

Ø 70

FERMAPORTE TRAPEZIO

In gomma MARRONE
In blister self da 4 pezzi



Cod. art.



3908B

CALAMITA IN NEODIMIO

In acciaio mm.8,8 x 2
Attrazione ca. 0,60 kg.



Cod. art.



29865

SCIVOLO IN TEFLON

mm. 35x35x45



Cod. art.



31260

PARACOLPI ADESIVI PIATTO

In blister self
Spessore (B) = mm.5



PARACOLPI ADESIVI PIATTO

Cod. art.	98203	98204
Misura	Ø mm. 13	Ø mm. 20

PARACOLPI ADESIVI MEZZALUNA

In blister self
Spessore (B) = mm.5



PARACOLPI ADESIVI MEZZALUNA

Cod. art.	98201	98200	98205
Misura	mm. 8	mm. 10	mm. 24

FELTRINI ADESIVI BIANCHI

Misure disponibili:
Ø : 16/18/20/22/24/26/28/30/32
Quadro : 20x20 - 25x25 - 30x30 - 40 x 40 - 100 x 100
Rettangolare : 25 x 50 - 50 x 100



FELTRINI ADESIVI BIANCHI

Cod. art.
4430

FELTRINI ADESIVI MARRONE

Misure disponibili:
Ø : 16/18/20/22/24/26/28/30/32
Quadro : 20x20 - 25x25 - 30x30 - 40 x 40 - 100 x 100
Rettangolare : 25 x 50 - 50 x 100



FELTRINI ADESIVI MARRONE

Cod. art.
4435

FELTRO IN ROTOLO MARRONE

H. cm.10 x 25 metri



Cod. art.
4436

FELTRO IN ROTOLO BIANCO

H. cm.10 x 25 metri



Cod. art.
4431



FELTRO ADESIVO IN ROTOLO

FELTRINI ADESIVI ASSORTITI

In blister self



31273

Cod. art. 31273
Misura Assortito



CORDINO PER VENEZIANE

Sezione mm. 3
Rotolo da metri 500



1788

Cod. art.
1799



Porta Abiti

GANCIO LEONZIO ORO
In acciaio laccato H. cm.15



Cod. art.
38471

GANCIO LEONZIO CROMO
In acciaio laccato H. cm.15



Cod. art.
38472

GANCIO LEONZIO BRONZO
In acciaio laccato H. cm.15



Cod. art.
38475

GANCIO LEONZIO NERO
In acciaio laccato H. cm.15



Cod. art.
38474

GANCIO LEONZIO BIANCO
In acciaio laccato H. cm.15



Cod. art.
38473

GANCIO LEONZIO FERRO BATTUTO
In acciaio laccato H. cm.15



Cod. art.
38476



GANCIO PORTA ABITI LEONZIO



GANCIO PORTA ABITI LEONZIO

GANCIO LADY ORO
In acciaio laccato H. cm.15



Cod. art.
3852 O

GANCIO LADY CROMO
In acciaio laccato H. cm.15



Cod. art.
3852 C

GANCIO LADY BRONZO
In acciaio laccato H. cm.15



Cod. art.
3852 BR

GANCIO LADY NERO
In acciaio laccato H. cm.15



Cod. art.
3852 N

GANCIO LADY BIANCO
In acciaio laccato H. cm.15



Cod. art.
3852 B

GANCIO LADY FERRO BATTUTO
In acciaio laccato H. cm.15



Cod. art.
3852 A



GANCIO PORTA ABITI LADY



GANCIO PORTA ABITI LADY

Porta Abiti

PORTA ABITI SEVEN

Supporto in legno verniciato
Dimensioni aperto cm.42

NOCE

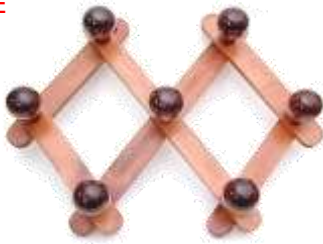

Cod. art. 3845NO

PORTA ABITI SEVEN

Supporto in legno verniciato
Dimensioni aperto cm.42

BIANCO



Cod. art. 3845BI

PORTA ABITI SEVEN

Supporto in legno verniciato
Dimensioni aperto cm.42

FRASSINO



Cod. art. 3845FR

APPENDI TUTTO PRONTY

Supporto in acciaio con 4 ganci
Dimensioni cm.45

NOCE



Cod. art. 3860

APPENDI TUTTO PRONTY

Supporto in acciaio con 4 ganci
Dimensioni cm.45

BIANCO



Cod. art. 3859

GANCIO VENTOSA ALPINA

In plastica Ø cm.6

GANCIO FIORE

In legno Ø cm.6



Cod. art. 39301

GANCIO FIORE

In legno Ø cm.10



Cod. art. 39303

GANCIO VENTOSA APPENDINO

In plastica Ø cm.7

GANCIO COCCINELLA

In legno cm.5



Cod. art. 39291

GANCIO COCCINELLA

In legno cm.10



Cod. art. 39292

GANCIO COCCINELLA

In legno cm.20



Cod. art. 39294



Ganci per cucina

GANCIO SMERALDO

In acciaio laccato Ø mm.30
Con biadesivo

ORO



Cod. art. 39180

GANCIO SMERALDO

In acciaio laccato Ø mm.30
Con biadesivo

CROMO



Cod. art. 3918C



GANCIO SMERALDO

In acciaio laccato Ø mm.30
Con biadesivo

BIANCO



Cod. art. 3918B

GANCIO SMERALDO

In acciaio laccato Ø mm.30
Con biadesivo

ASSORTITO



Cod. art. 3918

GANCIO SMERALDO

In acciaio laccato Ø mm.30
Con biadesivo

FERRO BATTUTO



Cod. art. 3918F

GANCIO SMERALDO

In acciaio laccato Ø mm.30
Con biadesivo

RAME



Cod. art. 3918R

GANCIO SMERALDO

In acciaio laccato Ø mm.30
Con biadesivo

OTTONE



Cod. art. 3918OT

BI-GANCIO

In acciaio H cm.5
Con viti

ORO



Cod. art. 39580

BI-GANCIO

In acciaio H cm.5
Con viti

CROMO



Cod. art. 3958C



BI-GANCIO

In acciaio H cm.5
Con viti

NERO



Cod. art. 3958N

BI-GANCIO

In acciaio H cm.5
Con viti

BIANCO



Cod. art. 3958B

GANCIO BOBBY

In acciaio laccato H. cm.5 con biadesivo

FERRO BATTUTO



Cod. art. 3950

GANCIO BOBBY

In acciaio laccato H. cm.5 con biadesivo

RAME



Cod. art. 3950B

Ganci per cucina

SUPERGANCIO

In plastica H. cm.8 con biadesivo

MARRONE



Cod. art. **3916**

SUPERGANCIO

In plastica H. cm.8 con biadesivo

BIANCO



Cod. art. **3915**

SUPERGANCIO

In plastica H. cm.8 con biadesivo

ASSORTITO



Cod. art. **3914**

SUPERGANCIO

In plastica H. cm.8 con biadesivo

TRASPARENTE



Cod. art. **3928**



SUPERGANCIO

METALGANCIO 1

In plastica con biadesivo



Cod. art. **3943**

METALGANCIO 3

In plastica con biadesivo



Cod. art. **3945**

METALGANCIO 4

In plastica con biadesivo



Cod. art. **3946**



METALGANCIO

GANCIO OVALE

In plastica con biadesivo

PICCOLO



Cod. art. **3928**

GANCIO OVALE

In plastica con biadesivo

GRANDE



Cod. art. **3927**



GANCIO OVALE IN PLASTICA

GANCIO VENTOSA ALPINA

In plastica Ø cm.6



Cod. art. **39164**



39164

MOLLA APPENDI PIATTI

In acciaio n°2 16/25



Cod. art. **98410**

MOLLA APPENDI PIATTI

In acciaio n°3 22/33



Cod. art. **98420**



MOLLA APPENDI PIATTI

GANCIO VENTOSA APPENDINO

In plastica Ø cm.7



Cod. art. **39165**



39165

Fermatovaglie

FERMA TOVAGLIE
In acciaio laccato cm.5 x 5
Per tavoli in plastica



Cod. art. **5989**

FERMA TOVAGLIE
In plastica cm.5 x 5
Per tavoli in plastica In blister da 4 pz.



Cod. art. **5992**

FERMA TOVAGLIE
In acciaio cm.4 x 5
Per tavoli in plastica



Cod. art. **5985**

FERMA TOVAGLIE
In acciaio cm.4 x 5



Cod. art. **5984**

FERMA TOVAGLIE GIGANTE
In acciaio cm.6 x 6,5



Cod. art. **5988**

PESI FERMA TOVAGLIA
In acciaio laccato H.cm.15 In blister 4 pz



Cod. art. **5993**

CINTINO IN COTONE
Beige/grigio



Cod. art. **1797 BG**

Misura Mt.5,5

CINTINO IN COTONE
Beige/grigio



Cod. art. **1798 BG**

Misura Mt.7,5

CINTINO IN POLIPROPILENE
Sezione mm.16
Rotolo da metri 50

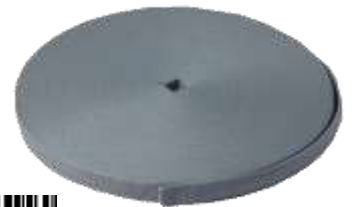

Cod. art. **1793**

CINTINO IN COTONE EXTRA
Beige/grigio



Cod. art. **1792 BG**

Misura Mt.50

CINTINO IN POLIPROPILENE
Misura metri 50



Cod. art. **1795 BG** **1795 BI**

Colore Beige/grigio Bianco

ALLACCIA BAGAGLIO ELASTICO



Cod. art. **3952** **3953** **3954**

Mis. cm. 80 100 120

CERNIERA PER SEDILE WATER

In zama



Cod. art. **5967**

Modello BLISTER



CERNIERA PER SEDILE WATER

In zama



Cod. art. **5968**

Modello Sfuso



CERNIERA PER SEDILE WATER

In plastica



Cod. art. **5969**

Modello Sfuso



STURA LAVANDINO A VENTOSA



Cod. art. **5975** **5976**

Misura \varnothing mm.120 \varnothing mm.150



SGOMBRATUBO A MOLLA



Cod. art. **5970** **5971** **5972**

Misura Mt. 2,5 Mt. 3,5 Mt. 5



GUARNIZIONE PER LAVELLI

Colore BIANCO



Cod. art. **3989** **3991**

Misura cm. 130 cm. 200



GURNIZIONE PER SANITARI

Sigillante di colore bianco
Sezione mm.22 x 3,2 metri



Cod. art.

0998



GUARNIZIONE PER LAVELLI

Colore TRASPARENTE



Cod. art. **3990** **3992**

Misura cm. 130 cm. 200



SALTARELLO PER LAVABO

In zama



SALTARELLO PER LAVABO

Cod. art.	5990	5991
Misura Ø	mm.36	mm.39,5

TAPPO COPRIFORO

In zama



TAPPO COPRIFORO

Cod. art.	5957	5958
Misura Ø	Cromo	Bianco

TAPPO CON MANIGLIA

In zama Ø nmm.52, in blister



Cod. art.	5955
-----------	------

AERATORE PER RUBINETTO

In zama



Cod. art.	5977	5978
Modello	Maschio	Femmina

AERATORE PER VASCA

In zama



Cod. art.	5979
-----------	------

TAPPO CROMATO PER LAVANDINO

In zama con catenella
In blister



TAPPO CROMATO PER LAVANDINO

Cod. art.	5951	5953
Misura Ø	mm.40	mm. 52

GRIGLIE PER LAVANDINO

In blister



GRIGLIE PER LAVANDINO



Cod. art.	5959 Ø 83
-----------	-----------



Cod. art.	5962 Ø 83
-----------	-----------



Cod. art.	5961 Ø 83
-----------	-----------



Cod. art.	5960 Ø 60
-----------	-----------

FILTRO PER LAVANDINO

In plastica Ø nmm.52



Cod. art.	5965
-----------	------

FILTRO PER LAVANDINO

In plastica Ø nmm.40



Cod. art.	5964
-----------	------

FILTRO PER LAVANDINO

In plastica Ø nmm.31



Cod. art.	5963
-----------	------



FILTRO PER LAVANDINO IN PLASTICA

RITOCO PER CERAMICA



RITOCO PER CERAMICA



Cod. art.	0880 AV	0880 CH	0881
f.to ml.10	Avorio	Champagne	Bianco

RITOCO PER ELETTRODOMESTICI



Cod. art. 0870

Formato Ritocco ml.10

FILTRO CAPPA



FILTRO CAPPA

Cod. art. 3995 3996

Formato cm.45 x 95 cm.45 x 20 mt

RITOCO ELETTRODOMESTICI

Pratico pennarello per eliminare difetti o graffi su tutti gli Elettrodomestici.
Colore Bianco



Cod. art.

0871

TOGLIRUGGINE



0886

Cod. art.

0886

OLEATORE PER MACCHINE DA CUCIRE



1410

Cod. art.

1410

SOTTO PORTA ADESIVO FLESSIBILE

Paraspifferi adesivo in pvc morbido e flessibile con feltrino di fondo.
Si applica sul fondo della porta.
Dimensioni: cm.100



SOTTO PORTA ADESIVO FLESSIBILE

Cod. art.	3983	3985
Colore	Bianco	Marrone

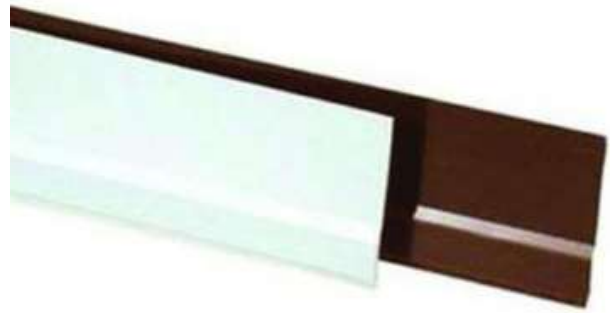

SOTTO PORTA ADESIVO RIGIDO

Paraspifferi adesivo in pvc rigido con spazzola fissa.
Si applica sul fondo della porta.
Adatto per fessure fino a 2 cm.



SOTTO PORTA ADESIVO RIGIDO

Cod. art.	3980	3981	3982
Colore	Trasparente	Bianco	Marrone



GUARNIZIONE ADESIVA IN SPUGNA BIANCA

Parafreddo adesivo in resina espansa.
Si applica su porte e finestre.
Adatto per fessure fino a 1 – 5 mm



GUARNIZIONE ADESIVA IN SPUGNA BIANCA

Cod. art.	3974	3975	3976	3977	3978
Misura	mm.10 x 8mt	mm.15 x 4mt	mm.20 x 4mt	mm.25 x 4mt	mm.30 x 4mt



GUARNIZIONE ADESIVA NERA

Guarnizione adesiva multiuso in resina espansa di elevato spessore, particolarmente indicata per isolare la porta del garage e le serrande dalle correnti d'aria.



GUARNIZIONE ADESIVA NERA

Cod. art.	39720	39721	39722	39723
Misura	mm.15 x 5 mm 10 metri	mm.20 x 5 mm 10 metri	mm.30 x 5 mm 10 metri	mm.30 x 10 mm 5 metri



GUARNIZIONE ADESIVA IN GOMMA EPDM

Guarnizione adesiva in gomma epdm estrusa.
Protegge dal freddo, dalle correnti d'aria, dalla polvere e dall'umidità facendo risparmiare energia.
Profilo "e", fessure 1 - 3,5 mm



GUARNIZIONE ADESIVA IN GOMMA EPDM

Cod. art.	3970	3971
Colore	Bianco	Marrone



PORTACHIAVI

TARGHETTA CON GIVOLARE

In plastica
Sfuse in scatola



Cod. art.

3901



TARGHETTE A SCATTO CON LENTE

In plastica
Sfuse in scatola



Cod. art.

3900



ANELLI SEGNACHIAVE PIENI

In gomma
Sfusi in scatola



Cod. art.

3902

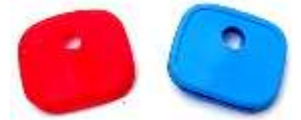

ANELLO PER CHIAVI IN ACCIAIO



Cod. art. 3911 3912 3913

Ø mm. 20 25 30

ANELLO IN ACCIAIO PIATTO con piega piatto diametro mm.30



Cod. art.

3917



MOSCHETTONE - LEVER

In metallo. Colore CROMO.
In cartella da 12 pz.



Cod. art.

3934



FLOATING-LUCKY

In Materiale Multi-Strato GALLEGGIANTE.
Lunghezza totale cm.13
In cartella da 6 pz.



Cod. art.

39385



FLOATING ANCHOR

In Materiale Multi-Strato GALLEGGIANTE.
Lunghezza totale cm.15
In cartella da 6 pz.



Cod. art.

39386



CORD BALL

In Cordino Intrecciato Bicolore.
Lunghezza totale cm.12,5.
In cartella da 12 pz.



Cod. art.

39383



Moschettone piccolo con anello

In metallo, mm.60



Cod. art.

3937

Moschettone piccolo con anello

In metallo, mm.5,5
In cartella da 12 pz.



Cod. art.

3935

Moschettone piccolo con anello

In metallo, mm.8,5
In cartella da 12 pz.



Cod. art.

3936

MOSCHETTONE A SCATTO

In alluminio.



Cod. art. 3956 3957

Colore mm. 50 mm. 60

MOSCHETTONE POMPIERE A VITE

In alluminio. mm.80



Cod. art.

3959A

**LIANTONIO
VERNICI**

PORTACHIAVI

PORTACHIAVI - HIPPOCAMPUS

In alluminio. Utilizzabile come apribottiglie.
In cartella da 12 pz.



39392

Cod. art.

39392



PORTACHIAVI - BIKE

In alluminio. Lunghezza cm.11,5.
In cartella da 12 pz.



39393

Cod. art.

39393



PORTACHIAVI - LIZARD

In alluminio. Utilizzabili come apribottiglie
In cartella da 12 pz.



39394

Cod. art.

39394



PORTACHIAVI - BILLIARD-KEY

Colori assortiti Ø cm.3
In cartella da 12 pz.



39384

Cod. art.

39384



FISCHIETTO - ALU MIDI

In alluminio. Con anello portachiaavi.
In cartella da 12 pz



39395

Cod. art.

39395



GANCIO SWORD - THREAD

Estensibile con meccanismo 'a molla'
In cartella da 12 pz.



39381

Cod. art.

39381



PORTACHIAVI STRINGA SILICONE

Costituito da una stringa in silicone.
Dotato di anello e moschettone.
In cartella da 12 pz.



39045

Cod. art.

39045



PORTACHIAVI - THICK SPIRAL

Moschettoni con molla a spirale.
Lunghezza totale cm.21
In cartella da 12 pz.



39043

Cod. art.

39043



PORTACHIAVI CATENA NICHEL

In metallo. Con moschettone ed anello.
Lunghezza totale cm.50 + anello.
In cartella da 12 pz.



3904

Cod. art.

3904



MOSCHETTONE - CH-MINI

MINI cm. 3,8 + anello.
In cartella da 12 pezzi



3938

Cod. art.

3938



PORTACHIAVI SGANCIABILE

In alluminio.
In cartella da 12 pz.



3903S

Cod. art.

3903 S



PORTACHIAVI SGANCIABILE

In alluminio.
In cartella da 12 pz.



3903

Cod. art.

3903



PORTACHIAVI TAGLIAUNGHIE

In metallo. Con limetta e catenella.
In cartella da 12 pz.
GRANDE



3960

Cod. art.

3960



PORTACHIAVI TAGLIAUNGHIE

In metallo. Con limetta e catenella.
In cartella da 12 pz.
PICCOLO



39601

Cod. art.

39601



LIANTONIO
VERNICI

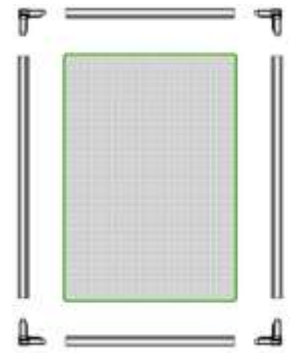

Profili in PVC



Guarnizione Nera
29810 rotolo da mt.150

2.

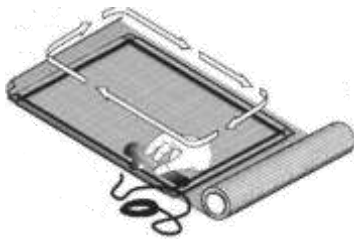

3.

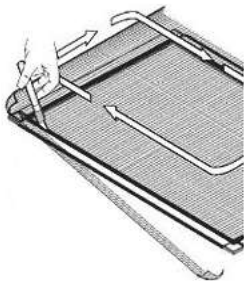

4.

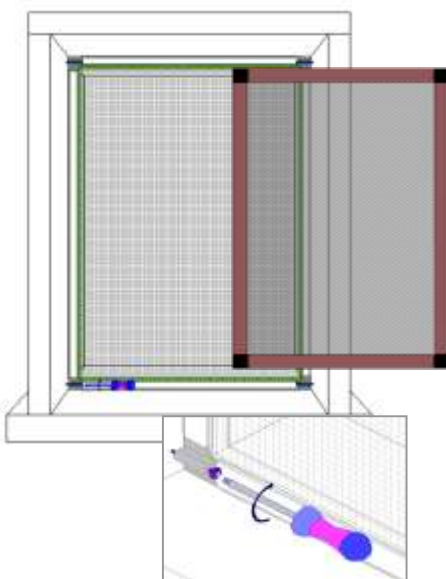

Asta	Cod. art.	29800	29805	29803
mt.2,50	Colore	Bianco	Marrone	Nero



Angolo semplice Bianco 29826



Angolo semplice Nero 29825

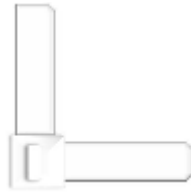

Angolo con perno Bianco 29821



Angolo con perno Nero 29820



Angolo con calamita Bianco 29831



Angolo con calamita Nero 29830



Raccordo con perno Bianco 29841



Raccordo con perno Nero 29840

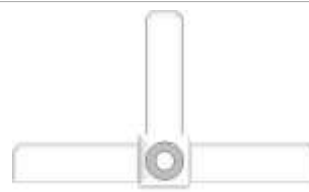

Raccordo con calamita Bianco 29851



Raccordo con calamita Nero 29850



Difesa dagli infestanti

 Copyr

Difesa dagli infestanti

RAT TABLET

Tavoletta prespalmata di colla speciale pronta all'uso.



Cod. art. 0755

Formato 2 x cm.19x28

RATADIOL 27

Esca Rodenticida pronta all'uso in forma di grani.



Cod. art. 0752

Formato Gr.140

BROMUS RED

Esca Rodenticida pronta all'uso in forma di pasta fresca.



Cod. art. 0754

Formato gr.150

KAT RAT

Erogatore per esche rodenticide.



Cod. art. 0760

Misura cm.20,5 x 13

GEL FORMICHE FORTE

GEL FORMICHE FORTE è un insetticida in formulazione gel efficace contro formiche comuni.



Cod. art. 07684

Formato Gr. 25

ESCA ANTIFORMICHE

AMP 1 RB è un'esca formulata come gel pronto all'uso.



Cod. art. 07685

Formato 2 x 10 gr.

Difesa dagli infestanti

GEL SCARAFAGGI FORTE

E' un insetticida in formulazione gel da utilizzare in interni, efficace contro le specie adulte di blattella germanica, blatta orientalis, periplaneta americana.



Cod. art. 07660

Misura Gr. 25

ESCA PER SCARAFAGGI

AMP 10 RB è un esca formulata come gel pronto all'uso per il controllo di tutte le specie di scarafaggi.



Cod. art. 07689

Formato 2 x 10 gr.150

VESPABLOCK

Registrazione Ministeriale n° 21460
Insetticida aerosol schiumogeno
per il controllo delle vespe.



Cod. art. 07677

Formato ml. 750

FLYSPRAY

Registrazione Ministeriale n° 1348
Insetticida aerosol a base di Piretro
Uccide rapidamente tutti
gli insetti mosche, zanzare,
pulci, scarafaggi, formiche
pulci, cimici e ragni



Cod. art. 07659

Formato ml.500

VESPA STOP

INSETTICIDA PER VESPE E CALABRONI
Insetticida aerosol contro mosche,
zanzare e vespe



Cod. art. 07681

Formato ml.750

SARCRAWIL

INSETTICIDA PER INSETTI STRISCANTI
Schiuma attiva per scarafaggi,
formiche e altri insetti striscanti



Cod. art. 07690

Formato ml.500

Difesa dagli infestanti

SPRIN

INSETTICIDA ACARICIDA

liquido pronto all'uso.
Per il trattamento di scarafaggi
formiche e pesciolini d'argento
Per uso interno ed esterno



Cod. art. 07675

Formato ml. 500



PERTRIN S

INSETTICIDA PER INSETTI VOLANTI E STRISCIANTI

liquido concentrato in fase acquosa ad azione abbattente e
residuale uso civile ed industriale



Cod. art. 07670

Formato ml. 250



CIPERTRIN T

INSETTICIDA CONCENTRATO

emulsionabile in base solvente.



Cod. art. 07672

Formato Lt.1



POLVERE DI PIETRO

INSETTICIDA PER INSETTI STRISCIANTI

Insetticida in polvere a base di Piretro
Per uso domestico contro scarafaggi
formiche, millepiedi ecc.
Anche indicata nella lotta
a pulci e cimici per ricoveri
di animali.



Cod. art. 07688

Formato gr. 250



FLY BAG



TRAPPOLA ECOLOGICA per il monitoraggio di mosca domestica e
moscone blu della carne.

FLY BAG è un sistema facile ed ecologico (privo di insetticidi) per
il monitoraggio delle mosche. Le mosche sono invitate ad entrare
nella trappola e una volta entrate non hanno possibilità di uscita.



Cod. art.

07629